

Operation manual

Pressure booster systems

GENO-FU-X, GENO-HR-X

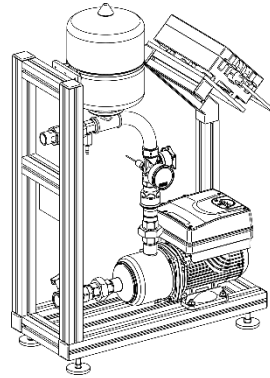

GENO-FU-X 2/40-1 N

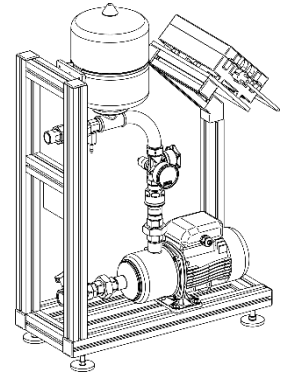

GENO-HR-X 2/40-1 N

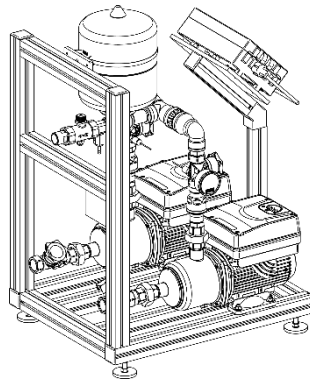

GENO-FU-X 2/40-2 N

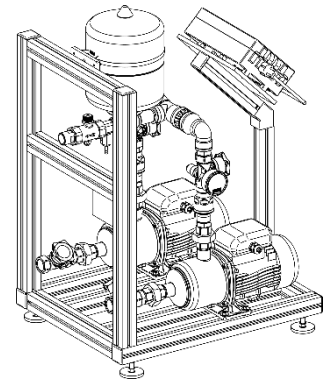

GENO-HR-X 2/40-2 N

Edition: October 2024
Order no. 730 960-inter_134

Grünbeck AG

Josef-Grünbeck-Str. 1 · 89420 Hoehstaedt
GERMANY

+49 9074 41-0 · +49 9074 41-100

www.gruenbeck.com · info@gruenbeck.com



A company certified by TÜV SÜD
in accordance with DIN EN ISO 9001,
DIN EN ISO 14001 and SCC

Table of contents

A General	6
1 Preface.....	6
2 General safety information.....	6
3 Shipping and storage.....	7
4 Disposal.....	8
4.1. Packaging.....	8
4.2. Product.....	8
B Basic information	9
1 Laws, regulations, standards.....	9
C Product description	10
1 Type plate.....	10
2 Intended use.....	10
3 Application limits.....	11
4 Product components.....	12
5 Function.....	13
5.1 Pressure booster system GENO-FU-X.....	13
5.2 Pressure booster system GENO-HR-X.....	13
6 Technical specifications.....	14
7 Scope of supply.....	20
8 Spare parts.....	20
8.1 Wearing parts.....	20
D Installation	21
1 General installation information.....	21
2 Water connection.....	22
3 Electrical installation.....	23
3.1 Notes.....	23
3.2 Power supply.....	24
3.3 Pipe connections within the pressure booster system.....	25
3.4 Connections to external or optional components.....	26
3.5 Cable connections for networked reverse osmosis OSMO-X.....	26
3.6 Connection diagram frequency converter (SM drive system).....	27
3.7 Information about GENO-FU-X with pressure control with SM drive system.....	28
4 Programming.....	29
4.1 Notes.....	29
4.2 Operating panel.....	29
4.3 Key function.....	30
4.4 Description of the LEDs.....	31
4.5 Display.....	34
4.6 Software parameters.....	38
4.7 Technical references.....	51
4.8 Troubleshooting.....	53
E Commissioning	55
1 Installation of pressure booster systems.....	56
2 Adjustment of target pressure (operating pressure) for pressure booster systems GENO-FU-X.....	57
3 Adjustment of switch-on pressure for pressure booster systems GENO-HR-X.....	57
F Operation	58
1 Preface.....	58
2 How to operate the control unit.....	58
2.1 Key function.....	58
2.2 Meaning of the LEDs red / yellow / green.....	59
2.3 Reading the state.....	59
2.4 System status display.....	60
2.5 Setting operating parameters – operator menu.....	60
G Troubleshooting	62
1 Basic information.....	62
2 Troubleshooting on the SM drive system (centrifugal pump with frequency converter).....	63
3 Warnings, faults on PBS control unit.....	66
4 Errors.....	66
H Inspection, maintenance	67
1 Basic information.....	67
2 Inspection.....	68
3 Maintenance.....	68
4 Operation log.....	70

Publisher's information

All rights reserved.

© Copyright by Grünbeck AG

Printed in Germany

Effective with the date of edition indicated on the cover sheet.

-Subject to modifications in line with technical advances-

Reprints, translations into foreign languages, electronic storage or copying of this operation manual, including extracts, only with explicit written approval of Grünbeck AG.

Any type of duplication not authorised by Grünbeck Wasseraufbereitung is a copyright violation and subject to legal action.

Responsible for contents:

Grünbeck AG

Josef-Grünbeck-Str. 1 | 89420 Hoechstädt

Germany

Phone +49 9074 41-0 | Fax +49 9074 41-100

www.gruenbeck.com | service@gruenbeck.de

Print: Grünbeck AG

Josef-Grünbeck-Str. 1, 89420 Hoechstädt; Germany

grünbeck



EU Declaration of Conformity

This is to certify that the system designated below meets the safety and health requirements of the applicable European guidelines in terms of its design, construction and execution.

This certificate will become void if the system is modified in a way not approved by us.

Manufacturer: Grünbeck Wasseraufbereitung GmbH
Josef-Grünbeck-Str. 1
89420 Hoechstädt
Germany

Responsible for documentation: Markus Pöpperl

System designation: Pressure booster system

System type: GENO-FU-X,
GENO-HR-X

Serial no.: Refer to type plate

Applicable guidelines: Machinery (2006/42/EC)
EMC (2014/30/EU)

Applied harmonised standards,
in particular: EN 809:2012-10,
EN 61000-6-1:2007-10,
EN 61000-6-3:2011-09,
EN 60335-2-41:2010-11

Applied national standards and
technical specifications, in
particular:

Location, date and signature Hoechstädt, Germany, 11.07.2018

i. 
M. Pöpperl
Dipl.-Ing. (FH)

Function of signatory: Head of Technical Product Design

A General

1 | Preface

Thank you for choosing a Grünbeck product. Backed by decades of experience in the area of water treatment, we provide custom-made solutions for all kind of processes.

All Grünbeck systems and devices are made from high-grade materials. This ensures trouble-free operation over many years when you treat your water treatment system with the required care. This operation manual supports you with important information. Please read the entire operation manual carefully before installing, operating or maintaining the system.

Customer satisfaction is our primary aim, and providing customers with qualified advice is crucial. If you have any questions concerning this device, possible extensions or general water and waste water treatment, our field service staff, as well as the experts at our headquarters in Hoechstädt, are available to help you.

Advice and assistance For advice and assistance please contact your local representative (refer to www.gruenbeck.com).

In case of emergency, please get in touch with our service hotline at +49 9074 41-444. We can connect you with the appropriate expert more quickly if you are able to provide the required system data. In order to have the required data handy at all times, please keep the precise device data to hand (refer to the type plate in chapter C-1).

2 | General safety information

2.1 Operating personnel Only persons who have read and understood this operating manual are permitted to work with our systems and devices. The safety instructions in particular are to be strictly adhered to.

2.2 Symbols and notes Important information in this operation manual is emphasised by symbols. Please pay particular attention to this information to ensure the hazard-free, safe and efficient handling of the system.



Danger! Failure to adhere to this information will cause serious or life-threatening injuries, major damage to property or inadmissible impurities in the drinking water.



Warning! Failure to adhere to this information may cause injuries, damage to property or contamination of the drinking water.



Caution! Failure to adhere to this information can result in damage to the system or other objects.



Note: This symbol characterises information and tips that make your work easier.



Tasks with this symbol are only allowed to be performed by Grünbeck's technical service/authorised service company or by persons expressly authorised by Grünbeck.



Tasks with this symbol are only allowed to be performed by trained and qualified electrical experts according to the VDE guidelines or according to the guidelines of a similar local institution.



Tasks with this symbol may only be performed by water suppliers or approved installation companies. In Germany, the installation company must be registered in the installation directory of a water supplier as per Section 12(2) AVBWasserV (German Ordinance on General Conditions for the Supply of Water).

2.3 Indication of specific dangers

Danger due to electrical energy! → Do not touch electrical components with wet hands! Disconnect the system from mains before starting work on electrical parts of the system. Have qualified experts replace damaged cables immediately.

Danger due to mechanical energy! System parts may be subject to overpressure. Risk of injuries and damage to property due to escaping water and unexpected movement of system parts. → Check pressure pipes regularly. Depressurise the system before starting repair or maintenance work on the system.

Hazardous to health due to contaminated drinking water! → The system should be installed by a specialist company only. Strictly adhere to the operation manual! Ensure that there is sufficient flow. Adhere to the pertinent guidelines when starting up the system after extended periods of standstill. Perform inspections and maintenance at the intervals specified!



Note: By concluding a maintenance contract, you ensure that all of the required tasks are performed on time. You may perform the interim inspections yourself.

3 | Shipping and storage



Caution! The systems and devices may be damaged by frost or high temperatures. Protect from frost during transportation and storage! Do not install or store the systems or devices next to objects, which radiate a lot of heat.

The system may only be transported and stored in its original packing. Ensure that it is handled with care and placed the right side up (as indicated on the packing).

4 | Disposal

Comply with the applicable national regulations.

4.1. Packaging

Dispose of the packaging in an environmentally sound manner.

4.2. Product



If this symbol (crossed-out wheelee bin) is on the product, this product or its electrical and electronic components must not be disposed of as household waste.



Dispose of electrical and electronic products or components in an environmentally sound manner.

If your product contains batteries or rechargeable batteries, dispose of them separately from your product.



For more information on take-back and disposal, go to www.gruenbeck.de.

B Basic information

1 | Laws, regulations, standards

In the interest of good health, rules cannot be ignored when it comes to the processing of drinking water. This operation manual takes into consideration the current regulations and stipulates information that you will need for the safe operation of your pressure boosting systems.



Among other things, the regulations stipulate that

- only approved companies are permitted to make major modifications to water supply facilities
 - and that checks, inspections and maintenance on installed devices are to be performed at regular intervals.
-

C Product description

1 | Type plate

The type plate is located at the frame. To speed up the processing of your enquiries or orders, please specify the data shown on the type plate of your device when contacting Grünbeck. Please add the necessary information to the overview below to have it readily available whenever necessary.

Pressure booster system					
GENO-HR-X:	□	/	□	□	- □ □
GENO-FU-X:	□	/	□	□	- □ □
GENO-FU-X NE:	□	/	□	□	- □ □
Serial number:	□	□	□	□	□ □
Order number:	□	□	□	□	□ □

2 | Intended use

The pressure booster systems GENO-FU-X, GENO-HR-X are in particular suitable for the low-noise water supply of small and medium-sized distribution networks within buildings.

The pressure booster systems GENO-FU-X, GENO-HR-X are designed for 100% continuous operation.

The "N" version, for example, is particularly suited for the delivery of raw water, softened water or partially demineralised water of a reverse osmosis system (permeate).

The system is activated by means of the control electronics installed on the system rack. The control unit features a backlit graphics display (70 x 35 mm) or operation is controlled from the reverse osmosis GENO-OSMO-X. The control unit has a master switch. All electrical power units are integrated. The control unit features two voltage-free signal/error signal contacts.

In the control unit, an operation log is administered by means of SD card. By interconnecting the control unit with the bus compatible OSMO-X control unit, the control unit can be connected to common bus systems on-site.

Two inputs are available for adjustment (releases) of the pressure booster system on site.

The pressure booster systems GENO-FU-X, GENO-HR-X are designed exclusively for use in industrial and commercial applications.

In the dual pressure booster systems GENO-FU-X, GENO-HR-X, the changeover between the centrifugal pumps is controlled either over time or in the event of a centrifugal pump failure. Thus, a steady centrifugal pump load and a redundancy of 100% is achieved for the double pressure booster systems.

Furthermore, adjustable cascade operation is possible for double pressure booster systems. Thus, the delivery rate can nearly be doubled.

The pressure booster systems GENO-FU-X, GENO-HR-X must not be used to pump liquids which contain solid, fibrous or abrasive substances. Furthermore, the pressure booster system must under no circumstances be used to pump chemicals or aggressive media.

Application advantages:

- Suction and pressure lines are installed on one side (water).
- Operating elements located on one side only, thus providing good accessibility for testing and setting purposes.
- Compact construction and design within the aluminium rack. Thus, the risk of damage, in particular during transport, is reduced.
- Self-deaerating pipes.
- Low-noise centrifugal pump due to multistage construction style.
- High operating safety of double systems as each centrifugal pump is equipped with a pressure sensor.
- Electronic centrifugal pump control by means of frequency converters, energy-saving, maintenance-free, maintenance free and safe (not with GENO-HR-X).
- Infinitely variable adjustment of the operating pressure by the + / - key on the frequency converter (not with GENO-HR-X).
- Freely adjustable switch-on pressure via pressure switch (GENO-HR-X).
- In case of double pressure booster systems, increase of delivery rate thanks to cascade switching →.

3 | Application limits

The application limits are defined by the intended use (chapter C-2) and the technical data (chapter C-6).

4 | Product components

- Aluminium rack with level adjustable feet.
- Multi-stage centrifugal pump(s) with standard suction.
- Control electronics with power unit, backlit graphics display, operating switch, operation log via SD card, voltage-free signal/fault signal contact, two inputs for centrifugal pump release. Can be interconnected with bus-compatible GENO-OSMO-X.
- Frequency converter with control/operating panel. Operating pressure adjustment by the $\boxed{+}$ / $\boxed{-}$ key. Display and LED-displays for signalling voltage supply, centrifugal pump state and operating state (not with GENO-HR-X).
- Non-return valve, pressure sensor or pressure switch, pressure gauge and draining valve as well as contact water meter to indicate system flow or cascade switching.
- Shut-off valves for each centrifugal pump on the suction and pressure side of the pump. Internal piping made of PE/PP with drinking water approval.
- Diaphragm expansion tank with forced flow.
- Power supply to be wired by others on site.

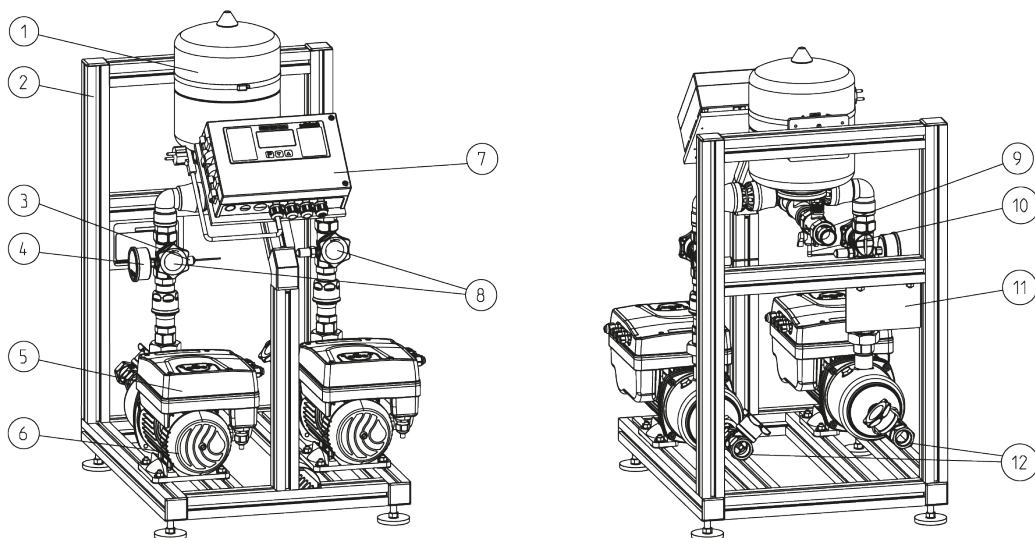

- | | | |
|---|----------------------------------|------------------------------|
| ① Diaphragm expansion tank | ⑤ Frequency converter (not HR-X) | ⑨ Contact water meter output |
| ② System rack | ⑥ Centrifugal pump | ⑩ Draining valve |
| ③ Pressure sensor (FU-X)/
Pressure switch (HR-X) | ⑦ Control unit | ⑪ Type plate |
| ④ Pressure gauge | ⑧ Shut-off valve pressure side | ⑫ Shut-off valve inlet |

Fig. C-1: Product components pressure booster system

5 | Function

5.1 Pressure booster system GENO-FU-X

The pressure booster system GENO-FU-X is speed-controlled via a pressure sensor and keeps the set pressure constant to a large extent. Smooth start-up and run-down of the centrifugal pump prevent water hammer. In addition, an expansion tank operating with forced flow, absorbs pressure fluctuations in case of major changes in the flow rate and reduces the switching frequency in case only small amounts are withdrawn.

In case of "0" consumption, the integrated, special pressure control initiates the time-delayed switch-off of the centrifugal pump.

The display and LEDs on the frequency converter control/operating panel provide information about the voltage supply, centrifugal pump state and operating state.

For further detailed information refer to chapter D Installation.

5.2 Pressure booster system GENO-HR-X

The pressure booster system GENO-HR-X operates with Flowatch circuitry. The switch-on pressure of the pressure booster system can be set via a pressure switch installed in the pressure side.

The centrifugal pump(s) pump(s) water through the contact water meter to the consumers via the downstream non-return valve. After the consumers have finished their withdrawal, the centrifugal pump continues to run briefly to refill the diaphragm expansion tank with partial through-flow with water. (Contact water meter gives no impulses) and then switches off.

6 | Technical specifications

Technical data	Pressure booster system GENO-FU-X				
	2/40-1 N	2/40-2 N	4/40-1 N	4/40-2 N	
Connection data					
Nominal diameter on suction/pressure side	DN 25/DN 25		DN 32/DN 25		
Max. power input	kW	0.7	1.4	1.4	2.7
Power supply	V/Hz	210 – 240/50 – 60			
Protection/protection class		IP 55/Ⓢ			
Admissible media to be delivered					
Raw water, soft water		suitable			
Permeate (= pure water of an RO system)		suitable			
Deionate (= ultra-pure water of an EDI system)		not suitable			
Performance data					
Delivery rate (best centrifugal pump efficiency)	m³/h	3.4		6.25	
Delivery rate	m³/h	0.8 – 5.2		1.4 – 10.2	
Delivery head	m	56 – 16		67 – 17	
Max. delivery head	m	55	55	66	66
Maximum rotational speed	rpm	3600			
Nominal pressure		PN 10			
Max. inlet pressure	bar	4	4	3.5	3.5
Suction characteristics		standard suction			
Diaphragm expansion tank content	l	8			
Centrifugal pump materials					
Impellers		1.4301			
Diffuser		1.4301			
Centrifugal pump housing		1.4301			
Shaft		1.4301			
Floating ring seal		ceramic / carbon / EPDM			
Dimensions and weights					
A Height of water inlet (suction piece)	mm	180			
B Height of water outlet (pressure piece)	mm	650	610	650	610
C Centre distance (system centre – centrifugal pump)	mm	–	163	–	163
D Centre distance (centre centrifugal pumps)	mm	–	325	–	325
E System width	mm	300	560	300	560
F Min. distance – engine fan	mm	min. 200			
G System depth	mm	660	660	680	680
H System height	mm	985	940	985	940
I Min. distance to pressure control	mm	min. 200			
Empty weight	kg	26	39	27	41
Operating weight, approx.	kg	36	49	37	51
Shipping weight, approx.	kg	36	48	37	50
Ambient data					
Water temperature	°C	5 – 40			
Ambient temperature	°C	5 – 40			
Order no.		730 640	730 641	730 642	730 643

Technical specifications	Pressure booster system GENO-FU-X				
	2/40-1 NE	2/40-2 NE	4/40-1 NE	4/40-2 NE	
Connection data					
Nominal diameter on suction/pressure side	DN 25/DN 25		DN 32/DN 25		
Max. power input	kW	0.7	1.4	1.4	2.7
Power supply	V/Hz	210 – 240/50 – 60			
Protection/protection class	IP 55/Ⓢ				
Admissible media to be pumped					
Raw water, soft water	suitable				
Permeate (= pure water of an RO system)	suitable				
Deionate (= ultra-pure water of an EDI system)	suitable				
Performance data					
Delivery rate (best centrifugal pump efficiency)	m³/h	3.4		6.25	
Delivery rate	m³/h	0.8 – 5.2		1.4 – 10.2	
Delivery head	m	56 – 16		67 – 17	
Max. delivery head	m	55	55	66	66
Maximum rotational speed	rpm	3600			
Nominal pressure	PN 10				
Max. inlet pressure	bar	4	4	3.5	3.5
Suction characteristics	standard suction				
Diaphragm expansion tank content	l	8			
Centrifugal pump materials					
Impellers	1.4404				
Diffuser	1.4404				
Centrifugal pump housing	1.4404				
Shaft	1.4404				
Floating ring seal	ceramic / carbon / EPDM				
Dimensions and weights					
A Height of water inlet (suction piece)	mm	180			
B Height of water outlet (pressure piece)	mm	650	610	650	610
C Centre distance (system centre – centrifugal pump)	mm	–	163	–	163
D Centre distance (centre centrifugal pumps)	mm	–	325	–	325
E System width	mm	300	560	300	560
F Min. distance – engine fan	mm	min. 200			
G System depth	mm	660	660	680	680
H System height	mm	985	940	985	940
I Min. distance to pressure control	mm	min. 200			
Empty weight	kg	29	45	29	45
Operating weight, approx.	kg	39	55	39	55
Shipping weight, approx.	kg	39	54	39	54
Ambient data					
Water temperature	°C	5 – 40			
Ambient temperature	°C	5 – 40			
Order no.		730 790	730 791	730 792	730 793

Technical specifications	Pressure booster system GENO-HR-X				
	2/40-1 N	2/40-2 N	4/40-1 N	4/40-2 N	
Connection data					
Nominal diameter on suction/pressure side	DN 25/DN 25		DN 32/DN 25		
Max. power input	kW	1.1	2.1	1.4	2.7
Power supply	V/Hz	230/50			
Protection/protection class		IP 55/Ⓢ			
Admissible media to be pumped					
Raw water, soft water		suitable			
Permeate (= pure water of an RO system)		suitable			
Deionate (= ultra-pure water of an EDI system)		not suitable			
Performance data					
Delivery rate (best centrifugal pump efficiency)	m³/h	2.0		4.0	
Delivery rate	m³/h	1.2 – 4.2		2.4 – 7.2	
Delivery head	m	52 – 23		50 – 16	
Min. delivery head	m	24		16	
Max. delivery head	m	58		60	
Nominal revolution speed (50 Hz)	rpm	2900			
Nominal pressure		PN 10			
Max. inlet pressure	bar	4			
Suction characteristics		standard suction			
Centrifugal pump materials					
Impellers		technical polymer			
Diffuser		1.4301			
Centrifugal pump housing		1.4301			
Shaft		1.4301			
Floating ring seal		ceramic / carbon / EPDM			
Dimensions and weights					
A Height of water inlet (suction piece)	mm	180			
B Height of water outlet (pressure piece)	mm	625	610	625	610
C Centre distance (system centre – centrifugal pump)	mm	–	163	–	163
D Centre distance (centre centrifugal pumps)	mm	–	325	–	325
E System width	mm	300	525	300	525
F Min. distance – engine fan	mm	min. 200			
G System depth	mm	660			
H System height	mm	960	940	960	940
I Min. distance to pressure control	mm	min. 200			
Empty weight	kg	25	38	26	40
Operating weight, approx.	kg	35	48	36	50
Shipping weight, approx.	kg	35	47	36	49
Ambient data					
Water temperature	°C	5 – 40			
Ambient temperature	°C	5 – 40			
Order no.		730 460	730 461	730 462	730 463

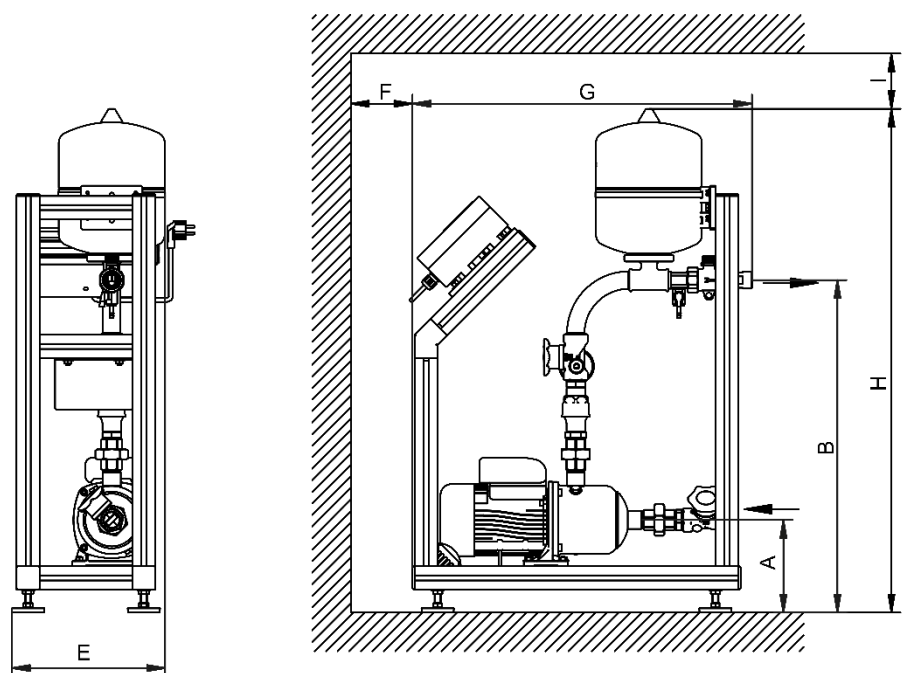

Fig. C-2: Dimensional drawing of single pressure booster system GENO-FU-X and GENO-HR-X

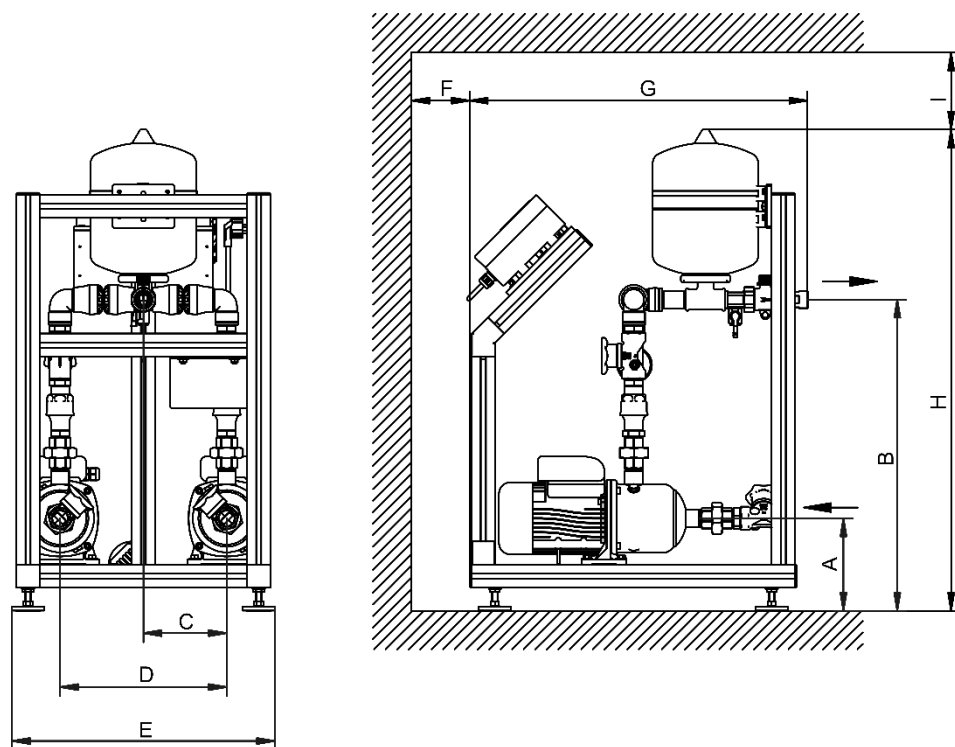
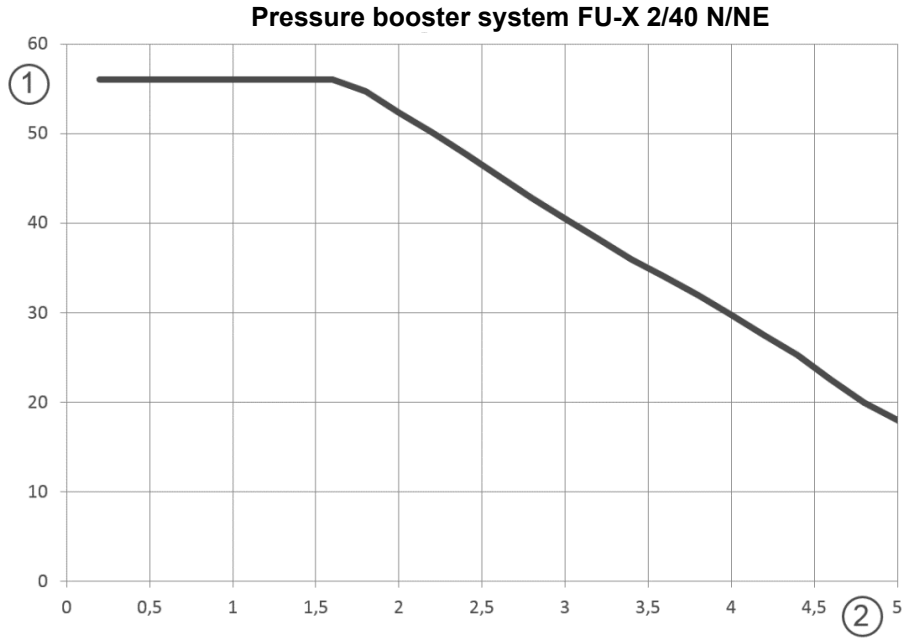
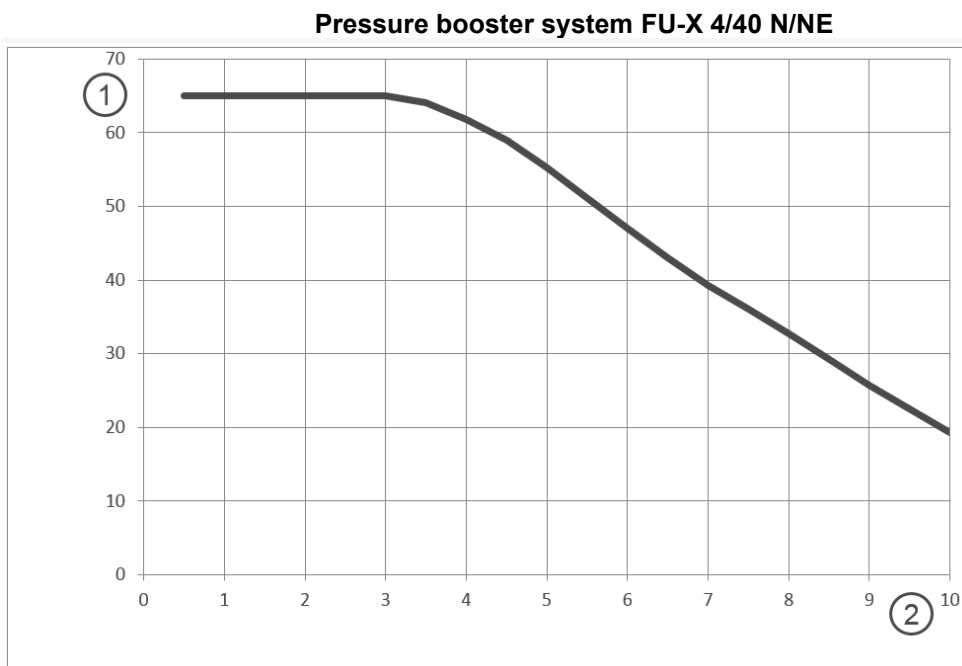

Fig. C-3: Dimensional drawing of double pressure booster system GENO-FU-X and GENO-HR-X



① Delivery head H in m

② Delivery rate in m³/h



① Delivery head H in m

② Delivery rate in m³/h

Fig. C-4: Centrifugal pump characteristic curve GENO FU-X2/40 N/NE, GENO-FU-X4/40 N/NE



Note: Speed-controlled centrifugal pumps maintain the delivery head (pressure) up to the point of intersection with the characteristic curve (assumption): primary pressure 0 bar).

Pressure booster system GENO-HR-X 4/40 N | GENO-HR-X 2/40 N

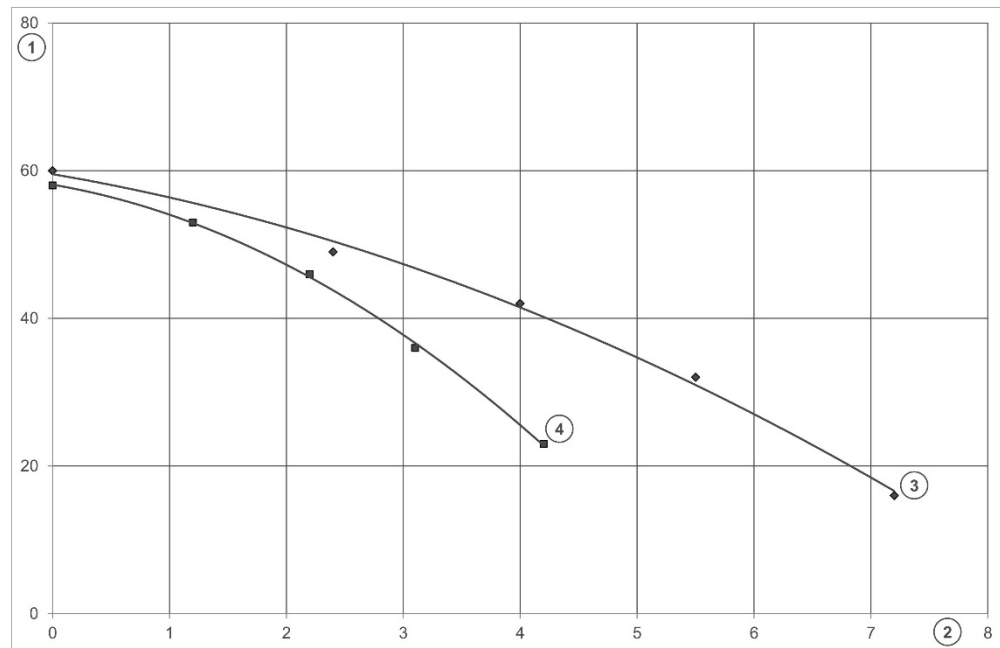

Pressure booster system

- ① Delivery head H in m ② Delivery rate in m³/h
③ GENO HR X 4/40 N ④ GENO HR X 2/40 N

Fig. C-5: Centrifugal pump characteristic curve GENO-HR-X 2/40, GENO-HR-X 4/40

7 | Scope of supply

Pressure booster system GENO-FU-X, GENO-HR-X ready for connection with operation manual. Delivered on a wooden palette 800 x 600 mm with cardboard casing.

8 | Spare parts

You may order spare parts and consumables from your local Grünbeck representative (refer to www.gruenbeck.com).

The components marked in Fig. C-6 are wearing parts.

8.1 Wearing parts



Note: Although these are wearing parts, we offer a limited warranty period of 6 months.

If there is a fault or wear on the centrifugal pump, replace the complete unit, refer to Fig. C-6, no. 5, and return it for repair. The pressure sensor installed in the pipe, Fig. C-6, no. 2, is an exception. This can be replaced individually if the error assignment is clear.

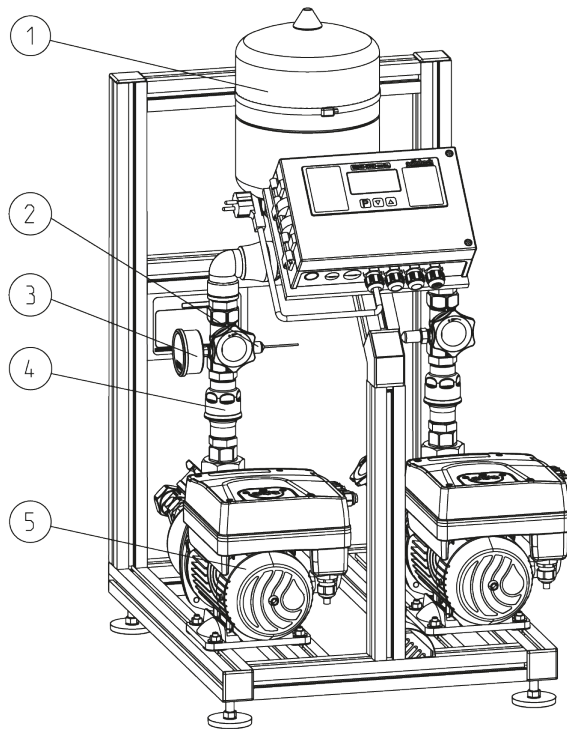

- | | |
|-----------------------------------|--------------------|
| ① Diaphragm expansion tank | ④ Non-return valve |
| ② Pressure sensor/pressure switch | ⑤ Centrifugal pump |
| ③ Pressure gauge | |

Fig. C-6: Wearing parts

D Installation

1 | General installation information

- Please observe local installation directives, general guidelines and technical specifications of the system.
- The installation site must be accessible for maintenance work, flood and frost-proof and ensure the system's protection from chemicals, dyes, solvents and vapours. The system must not be operated in a dusty environment or if acid fumes or corrosive or potentially explosive gases are present.
- If the installation location of the pressure booster system is 1000 m or more above sea level, the performance losses of the centrifugal pump must be taken into account.
- To protect the pressure booster systems from running dry, an external float or pressure switch must be provided!



Note: Only if the pressure booster system is not networked with the OSMO-X control unit.

- The system should be installed in pipes of the same dimensions as the nominal connection diameters of the system.
- Depending on the withdrawal conditions it might be reasonable, as the case may be even necessary, to have an additional diaphragm expansion tank installed by others on site (e.g. if in case of a relatively speedy start of the withdrawal and a high flow rate, the drop in pressure shall be kept low).

2 | Water connection



The installation of a pressure booster system represents a major interference with the drinking water system. Therefore, only authorised experts are allowed to install such systems.

Preliminary work

Unpack the system and possible accessories and check for completeness and soundness.

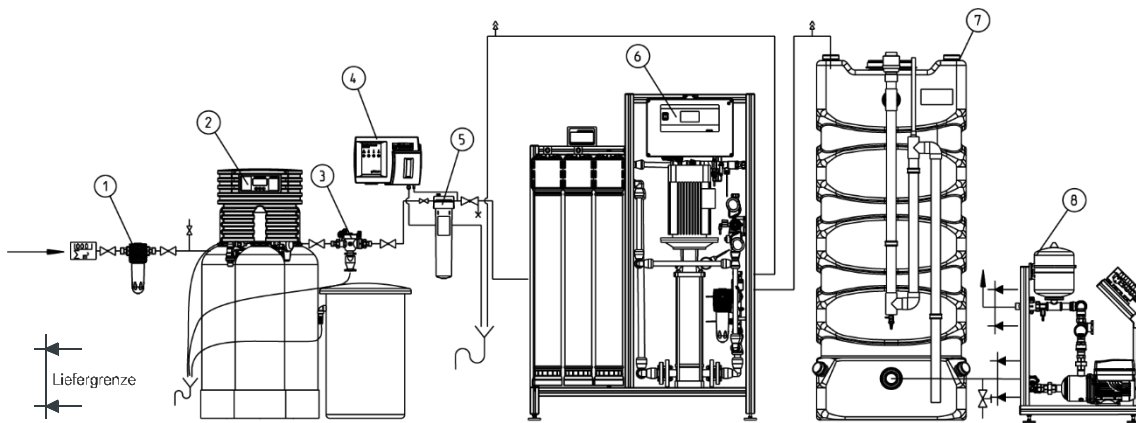

- | | |
|---|----------------------------------|
| ① Drinking water filter BOXER X | ⑤ Activated carbon filter AKF |
| ② Delta-p water softener | ⑥ GENO-OSMO-X |
| ③ Euro system separator GENO-DK 2 | ⑦ Permeate tank with level probe |
| ④ Hardness control measuring device softwatch | ⑧ Pressure booster system |

Fig. D-1: Installation example for pressure booster system GENO-FU-X

Water connection activities

- Prepare respectively check the installation provided by others on site while taking into consideration the installation instructions and general guidelines.
- Place the system at the installation site.
- Compensate for uneven floors by adjusting the rubber feet, if necessary.
- Install the system while observing the installation instructions. Refer also to dimensional drawing Fig. C-2 / C-3.
- Connect the pressure booster system to the suction and pressure sides. Only use corrosion-resistant materials.
- For maintenance work, a shut-off valve must be provided on site immediately after the pressure booster system!

3 | Electrical installation

3.1 Notes



The tasks described below are only allowed to be performed by qualified electrical experts according to the VDE guidelines or according to the guidelines of a similar local institution.



Warning! Pressure booster systems must be grounded at the beginning of installation work.



Danger due to electrical energy!

Voltage may be present at terminals L, N and PE as well as at the feed line to voltage-free contacts.



Danger due to electrical energy!

In case the mains cable is damaged, it may only be replaced by trained electricians or electronics experts.



Danger due to electrical energy!

Prior to any work on the system's electrical or mechanical components, disconnect the centrifugal pump's frequency converter from the mains supply.

Wait for at least 5 minute after disconnection from mains before carrying out any work on the frequency converter (SM drive system) to allow the capacitors in the internal circuit to discharge.



Warning! When making the connections, the relevant rules and regulations must be observed. Make sure that the type of power source, the supply voltage and frequency match the ratings of the TKS system shown on the data plate. Provide suitable general protection against short circuits on the electrical power line.



Warning! Install the system in such a way that the control unit remains easily accessible if it is necessary to switch off the system.



Caution! The system's power supply is only allowed to be connected after the system has been filled and the centrifugal pump has been deaerated. Danger of the centrifugal pump running dry due to air entrapment.



Caution! A highly sensitive residual current circuit breaker (30 mA) must be provided on site in the feeder (RCD type B).



Caution: All electrical cables must be protected from high temperatures, vibrations and mechanical damage.

3.2 Power supply

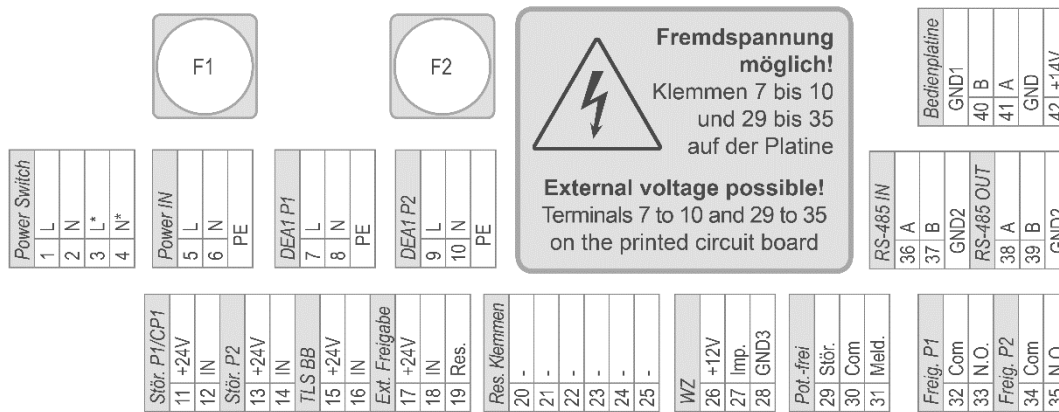

Fig. D-2 Connection diagram for the pressure booster system control unit

F1 = Pump DEA1P1

F2 = Pump DEA1P2

System type	Fuses F1 = F2
GENO-FU-X (all versions)	T 10 A
GENO-HR-X 2/40-x N	T 4 A
GENO-HR-X 4/40-x N	T 5 A

3.3 Pipe connections within the pressure booster system

The following connections are preset internally at the factory and must not be modified:

From control unit PBS	to component		Line	Signal	
1 L	Mains switch (all-pole disconnecting)	Switched	H05VV-F 5G1.0 mm ²	1	
2 N		Connection to terminals 5/6		2	
3 L*				3	
4 N*		4			
5 L	Mains cable		H05VV-F 3G0.75 mm ²	Br	
6 N				Bl	
PE				Ye-gn	
7 L	Feed line centrifugal pump P1		H05RN-F 3G1.5 mm ²	2 (L)	
8 N				3 (N)	
PE				1 (PE)	
9 L	Feed line centrifugal pump P2		H05RN-F 3G1.5 mm ²	2 (L)	
10 N				3 (N)	
PE				1 (PE)	
System type GENO-FU					
11 +24V	Error signal centrifugal pump P1		LiYY 2x0.5 mm ²	C	4
12 IN				NO	5
13 +24V	Error signal centrifugal pump P2		LiYY 2x0.5 mm ²	C	4
14 IN				NO	5
System type GENO-HR					
11 +24V	Pressure switch CP1 as normally open contact (NO)		LiYY 2x0.5 mm ²	1	
12 IN				2	
19 Res.	Reserved terminals				

(*) If the control unit of the pressure booster system is networked with the reverse osmosis control unit OSMO-X, this signal is allowed to be omitted because the dry-run protection information is transmitted by the control unit OSMO-X via the RS485 serial port.

From control unit PBS	to component	Line	Signal			
20 -	Reserved terminals					
21 -						
22 -						
23 -						
24 -						
25 -						
26 +12V	Water meter	LiYY 3x0.25 mm ²	+ 12 V=	Wh		
27 Imp			pulse	Gn		
28 GND			GND	Br		
32 Com	Voltage-free alarm release P1	Not used for GENO-FU and GENO-HR and can be evaluated on site: Max. switching capacity 48 V= / 1 A				
33 N.O.	Voltage-free alarm release P2					
34 Com						
35 N.O.						
GND1	Connection to the operating board	LiYY 5x0.34 mm ²	GND-RS	Wh		
40 B			RS485A	Gr		
41 A			RS485B	Gn		
GND			GND	Ye		
42 +14V					+ 14 V=	Br

System type GENO-FU:

The following factory cable connections must not be changed or removed:

- Jumper on the Low+/Low- connecting terminals (connecting terminal 13/14).
- Pressure sensor on the P1+P1 connecting terminals (connecting terminal 9/10).
- Jumper on the start/stop connecting terminals (connecting terminal 11/12).

3.4 Connections to external or optional components

From control unit PBS	to component	Line	Signal
15 +24V	Dry-run protection BB1 CL1.4 (*), opens when the level falls below the minimum level		
16 IN			
17 +24V	External operational release, voltage-free contact on site is closed for operation		
18 IN			
29 Stör.	Collective fault		Max. 250 V~ / max. 3 A each active Signal
30 Com	Common root		
31 Meld.	Signal contact		

3.5 Cable connections for networked reverse osmosis OSMO-X

From control unit PBS	to component	Line	Signal
38A	Bus line to OSMO-X control unit	LiYY 3x0.25 mm ² (*)	RS485 A
39B			RS485 B
GND2			RS485-GND

(*) With cable length < 20 m: Use LiYcY 3 x 0.25 mm² and connect the shielding at one end either in the OSMO-X control unit or IONO-matic WE/control unit PBS at a free PE terminal.

With cable length > 20 m refer to Technical Service Manual chapter 1.3.

3.6 Connection diagram frequency converter (SM drive system)

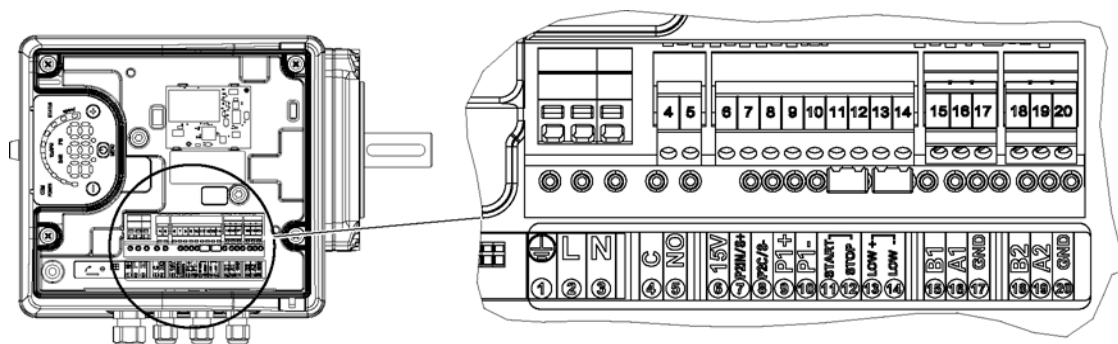

Fig. D-2 Electrical connection diagram of frequency converter

Table D-1: Connecting terminals				
Connection	Terminal	Number	Comments	To be observed
Feed line frequency converter	PE	1	Protective earth conductor	
	L	2	Phase 230V- 50/Hz	
	N	3	Neutral conductor	
Error signal	C	4	COM – error state relay	
	No	5	NO – error state relay	
Auxiliary voltage supply	15V	6	Auxiliary voltage supply +15 V DC	15 VDC, Σ max. 100 mA
Analog 0-10 V	P2IN/S+	7	Actuator mode 0-10 V input	0 – 10 VDC
	P2C/S-	8	GND for 0-10 V input	GND, earthing (for S+)
External pressure sensor [also differential pressure]	P1+	9	External power supply sensor +15 VDC	15 VDC, Σ max. 100 mA
	P1-	10	External sensor 4-20 mA input	4-20 mA
External start/stop	START	11	External ON/Off input	Presetting short-circuit Centrifugal pump ready to RUN
	STOP	12	Earthing for external ON/OFF input	
External water shortage	LOW+	13	Low water inlet	Presetting short-circuit Detection of water shortage: activated
	LOW-	14	Earthing for low water input	
Communication bus	B1	15	RS485 port 1: RS485-1N B (-)	ACT, HCS control mode: RS 485 port 1 for external communication MSE, MSY control mode: RS 485 port 1 for multi-centrifugal pump systems
	A1	16	RS485 port 1: RS485-1P A (+)	
	GND	17	GX, electronic earthing	
Communication bus	B2	18	RS485 port 2: RS485 port 2: RS485-2N B (-) only active with optional module	RS 485 port 2 for external communication
	A2	19	RS485 port 2: RS485 port 2: RS485-2P A (+) only active with optional module	
	GND	20	GX, electronic earthing	

3.7 Information about GENO-FU-X with pressure control with SM drive system

The SM drive system consists of the following components:

- 1 centrifugal pump with permanent magnet motor IE5
- 1 frequency converter
- 1 pressure sensor

Mode of operation of the centrifugal pump

- Start and stop of the centrifugal pump depend on the adjustable set point (operating pressure) of the frequency converter.
- Upon request by the consumer (opened water tap), water flows out of the diaphragm expansion tank.
- If the line pressure drops below the start setting, the centrifugal pump starts. The motor speed is controlled in such a way that the pressure remains constant even when the consumer demand increases.
- If the consumer demand decreases, the centrifugal pump runs slower at first, fills the diaphragm expansion tank and then stops if the set point (operating pressure) is reached.

4 | Programming

4.1 Notes



Note: Before you start programming, read the following instructions carefully and follow them to avoid incorrect settings that can cause malfunctions.

All changes must be made by an approved installation company or by Grünbeck's technical service/authorised service company (www.gruenbeck.com).



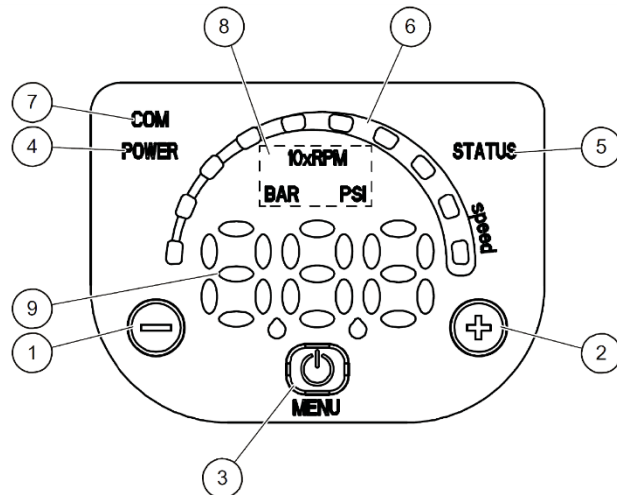

4.2 Operating panel



Item	Designation	Chapter
①	Minus key	D-4.3
②	Plus key	D-4.3
③	START/STOP and menu access key	D-4.3
④	POWER LED	D-4.4.1
⑤	State LED	D-4.4.2
⑥	Rotational speed LED strip	D-4.4.3
⑦	Communication LED	D-4.4.4
⑧	Measuring unit LEDs	D-4.4.5
⑨	Display	D-4.5

Fig. D-3: Control panel

4.3 Key function

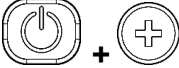
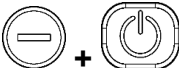
Button	Function
	<ul style="list-style-type: none"> • Main view (refer to chapter D-4.5.1): reduces the required value for the selected control mode. • Parameters menu (refer to chapter D-4.5.2): reduces the displayed parameter list. • Parameter display / edit (refer to chapter D-4.5.2): reduces the value of the displayed parameter. • Zero pressure auto calibration (refer to chapter D-4.6, P44): automatic calibration of the pressure sensor.
	<ul style="list-style-type: none"> • Main view (refer to chapter D-4.5.1): increases the required value for the selected control mode. • Parameters menu (refer to chapter D-4.5.2): increases the displayed parameter list. • Parameter display / edit (refer to chapter D-4.5.2): increases the value of the displayed parameter. • Zero pressure auto calibration (refer to chapter D-4.6, P44): automatic calibration of the pressure sensor.
	<ul style="list-style-type: none"> • Main view (refer to chapter D-4.5.1): START/STOP of the centrifugal pump. • Parameters menu (refer to chapter D-4.5.2): switches to parameter display / edit. • Parameter display / edit (refer to chapter D-4.5.2): saves the value of the parameter.
 (5 sec.)	<ul style="list-style-type: none"> • Main view (refer to chapter D-4.5.1): switches to parameter selection. • Parameters menu: switches to the main view.
	<ul style="list-style-type: none"> • Main view: switches between speed and delivery head (refer to chapter D-4.5.1).
	<ul style="list-style-type: none"> • Main view: switches between rotational speed and delivery head (refer to chapter D-4.5.1).

4.4 Description of the LEDs

4.4.1 Power LED)

At ON (Power) the centrifugal pump is supplied with electrical current and the electronic devices are ready for operation.

4.4.2 State LED

LED	STATUS
Off	Centrifugal pump unit stopped.
Green continuous light	Centrifugal pump unit in operation.
alternately green – orange	Non-locking alarm during operation of the centrifugal pump unit (warning).
Orange continuous light	Non-locking alarm when the centrifugal pump unit is stopped (warning).
Red continuous light	Locking error, the centrifugal pump unit cannot be started (fault).

4.4.3 Rotational speed LED strip

Consists of 10 LEDs; each of them represents the speed range between parameter P27 (min. speed) and parameter P26 (max. speed) in stages between 10 and 100%.

LED strip	Status
On	Motor in operation; the speed corresponds to the percentage stages that are indicated by the switched-on LEDs on the strip (e.g.: 3 LEDs ON = rotational speed 30%).
First LED flashes	Motor in operation; the speed is below the absolute minimum value, P27.
Off	Motor stopped.

4.4.4 Communication LED

- Condition 1**
- The communication bus protocol is Modbus RTU; parameter P50 is set to the Modbus value.
 - No optional communication module is used.

LED	STATUS
Off	The unit does not recognise any valid Modbus signals at the terminals intended for the communication bus.
Green continuous light	The unit has detected a communication bus at the respective terminals and detected the correct addressing.
Green flashing light	The unit has detected a communication bus at the relevant terminals, but has not been addressed correctly.
From continuous green light to Off	The unit has not detected a valid Modbus RTU signal for at least 5 seconds.
From continuous green light to flashing light	The unit has not been properly addressed for at least 5 seconds.

- Condition 2**
- The communication bus protocol is BACnet MS/TP; parameter P50 is set to the BACnet value.
 - No optional communication module is used.

LED	STATUS
Off	The unit has not received any valid requests from other BACnet MS/TP devices for at least 5 seconds.
Continuous light On	Information is exchanged between the unit and another BACnet MS/TP device.

- Condition 3**
- A multi-pump control mode is selected (e.g. MSE or MSY).
 - No optional communication module is used.

LED	STATUS
Off	The unit has not received any valid requests from other BACnet MS/TP devices for at least 5 seconds.
Continuous light On	Information is exchanged between the unit and another BACnet MS/TP device.

- Condition 4**
- The optional communication module is used.

LED	STATUS
Off	RS485 or wireless connection faulty or insufficient.
Flashing light	Information is being exchanged between the unit and the communication module.

4.4.5 Measuring unit LED

LED on	Measurement active	To be observed
10 x RPM	Impeller rotational speed	The display shows the rotational speed in 10xRPM.
BAR	Hydraulic delivery head	The value of the delivery head is shown on the display in bar.
PSI		The value of the delivery head is shown on the display in PSI.



4.5 Display











4.5.1 Main view

Display	Mode	Comments
OFF	OFF	Contacts 11 and 12 (refer to chapter D-3.6) are not short-circuited.



Note: OFF mode has a lower display priority than STOP mode.

Display	Mode	Comments
STOP	STOP	<p>Centrifugal pump stopped manually.</p> <p>If the centrifugal pump is switched on after setting P04 = OFF (refer to chapter D-4.6.1), it is stopped; the motor is not in operation and STB flashes (STOP → STOP).</p> <p>For manually stopping the centrifugal pump:</p> <p>Example A Control modes (explanation of control mode refer to chapter D -4.6.3) HCS, MSE, MSY with required start value (delivery head) of 4.20 bar and 0.5 bar minimum value: 4.20 BAR →  press once → STOP.</p> <p>Example B ACT control mode (explanation of control mode refer to chapter D-4.6.3) with required starting value (rotational speed) of 200 10xRPM and 80 10xRPM minimum value: 200 10xRPM →  press once → STOP.</p>
Display	Mode	Comments







ON	ON	<p>Centrifugal pump on; the motor starts depending on the selected control mode.</p> <p>Appears for a few seconds if contacts 11 and 12 (refer to chapter D-3.6) are short-circuited and the centrifugal pump is not in STOP mode.</p> <p>For manually setting the centrifugal pump to ON:</p> <p>Example A Control modes (explanation of control mode refer to chapter D-4.6.3) HCS, MSE, MSY, which reach the required value (delivery head) of 4.20 bar, starting from 0.5 bar minimum value after a manual stop:</p> <p>STP →  press once → ON → and after a few seconds... → 4.20 BAR.</p> <p>Example B Control mode (explanation of control mode refer to chapter D-4.6.3) ACT, which reaches the required value (rotational speed) of 200 10xRPM, starting from 80 10xRPM minimum value after a manual stop:</p> <p>STP →  press once → ON → and after a few seconds... → 200 10xRPM.</p> <p>During centrifugal pump operation, the actual values for delivery head and rotational speed can be displayed:</p> <p>Example A Control modes (explanation of control mode refer to chapter D-4.6.3) HCS, MSE, MSY, at actual delivery head 4.20 bar and corresponding actual rotational speed 352 10xRPM:</p> <p>4.20 BAR →  +  → 352 10XRPM → after 10 seconds or  +  → 4.20 BAR.</p> <p>Example B ACT control mode (refer to chapter D-4.6.3 for explanation of control mode) at actual rotational speed 200 10xRPM and corresponding actual delivery head 2.37 bar:</p> <p>200 10xRPM →  +  → 2.37 BAR → after 10 seconds or  +  → 200 10xRPM.</p>
----	----	---

4.5.2 Parameters menu view

You can use the Parameters menu:

- To select all parameters (refer to chapter D-4.6).
- To access Parameters Editing/Visualisation (refer to chapter D-4.3).

Parameters	Comments
------------	----------

Power on	<p>After switching on, the Parameters menu view is accessible with P23 = ON, P20 flashes: P20 → P20.</p> <p>Enter the password to view and edit the parameters.</p>
Password timeout	<p>If no key is pressed for more than 10 minutes from the last time the Parameters menu was displayed when P23 = ON, viewing and editing the parameters is deactivated.</p>
Parameters menu	<p>If P23 = OFF or after password input (P20), the parameters can be displayed and edited. When the Parameters menu is accessed, the display shows:</p> <p>P01 → P01 P02 → P02 ... P69 → P69</p> <p>If the parameter is flashing, it means that a selection is possible.</p>
Parameters Editing/Visualisation	<p>The value of a parameter can be changed using the keys or the Modbus and BACnet communication protocol.</p> <p>When you return to the Parameters menu, the displayed parameter list is automatically increased. For further information refer to chapter D-4.6.</p> <p>Example A (P20) from 000 to 066: P20 → P20 →  → 000 → 000 →  ... to ... → 066 → 066 →  sets the desired value → P21 → P21</p> <p>Example 2 (P26) from 360 to 300: P26 → P26 →  → 360 → 360 →  ... bis ... → 300 → 300 →  sets the desired value → P26 → P26.</p>

4.5.3 Alarm and error display









Parameters	Comments
Alarms (alarm signals)	<p>In the event of an alarm, the corresponding code is displayed alternately with the main display.</p> <p>For example:</p> <p>A01 → 3.56 (e.g. BAR)</p> <p>A02 → 285 (e.g. 10xRPM)</p> <p>...</p> <p>For further information refer to chapter D-4.8.</p>
Errors	<p>If an error occurs, the corresponding code number is shown on the display.</p> <p>For example:</p> <p>E01</p> <p>E02</p> <p>...</p> <p>For further information refer to chapter D-4.8.</p>

4.6 Software parameters

The parameters are coded differently in the manual depending on the type

Coding	Parameters
No coding	Applies to all units.
G	Global parameter, applies to all centrifugal pumps of a multi-pump system.
	Write-protected.

4.6.1 Parameter state

No.	Parameters	Measuring unit	Comments
P01	Required value 	bar/psi/ rpmx10	<p>This parameter displays the SOURCE and VALUE of the required active value.</p> <p>The display switches between SOURCE and VALUE every 3 seconds.</p> <p>SOURCES:</p> <p>SP: Internally required set point, which refers to the selected control mode.</p> <p>VL: Externally required speed set point, which refers to the input 0-10V.</p> <p>VALUE can represent a speed or delivery head according to the selected control mode. For delivery head, the measuring unit is determined by parameter P41.</p>
P02	Effective Required Value 	bar	<p>Required active value, calculated on the basis of parameters P58 and P59. This parameter is only effective in control mode MSE or MSY. For further information on the calculation of P02 refer to chapter D-4.7.2.</p>
P03	Regulation Restart Value [0÷100] 	%	<p>Determines the value for starting after a centrifugal pump stop as a percentage of the value P01. If the required value has been reached and there is no more consumption, the centrifugal pump stops. The centrifugal pump restarts when the pressure falls below P03.</p> <p>P03 is valid if:</p> <p>other than 100% (100%=Off)</p> <p>Control mode HCS, MSE or MSY.</p> <p>Standard: 100%.</p>
P04	Auto-start [OFF-ON] 		<p>If P04 = ON, the centrifugal pump starts automatically after shut-down of the power supply.</p> <p>If the centrifugal pump is switched on after setting P04 = OFF (refer to P. 6.5.1), it is stopped; the motor does not run and STB flashes ( → ).</p> <p>Standard: ON.</p>
P05	Operating time months 		<p>This parameter shows the total operating time in months in addition to P06.</p>
P06	Operating time hours 	h	<p>This parameter shows the total operating time in hours in addition to P05.</p>

No.	Parameters	Measuring unit	Comments
P07	Motor Time Months		This parameter shows the total operating time in months in addition to P08.
P08	Motor time hours	h	This parameter shows the total operating time in hours in addition to P07.
P09	1st error		<p>This parameter saves the last error that occurred in chronological order. The displayed information switches between the values:</p> <p>(Exx): xx reports the error code</p> <p>(Hyy): yy is the value of hours in relation to P05-P06 when the error Exx occurred.</p> <p>(Dww): ww is the value of days in relation to P05-P06 when the error Exx occurred.</p> <p>(Uzz): zz is the value of weeks in relation to P05-P06 when the error Exx occurred.</p> <p>Display examples:</p> <p>E04 → K10 → d03 → U15</p>
P10	2nd error		Saves the penultimate error in chronological order. Further features: like P09.
P11	3rd error		Saves the third-from-last error in chronological order. Further features: like P09.
P12	4th error		Saves the fourth-from-last error in chronological order. Further features: like P09.
P13	Power Module Temperature	°C	Temperature of the power module.
P14	Inverter Current	A	This parameter indicates the actual current value supplied by the frequency converter.
P15	Inverter Voltage	V	This parameter indicates the estimated current input voltage value of the frequency converter.
P16	Motor Speed	rpmx10	This parameter indicates the current rotational speed of the motor.
P17	Software version		This parameter displays the software version of the control panel.

4.6.2 Parameter Settings

No.	Parameters	Comments
P20	Password [0÷999]	The user can enter the system password here, which enables access to all parameters: This value is comparable to that stored under P22. If the correct password is entered, the system will remain unlocked for 10 minutes.
P21	Jog mode [MIN÷MAX*]	Deactivates the internal control of the unit and forces the current control mode (ACT): The motor starts and the value P21 is the temporary ACT set point. It can be changed by entering a new value for P21 without confirmation; otherwise it causes the temporary control to be exited immediately.
P22	System password [1÷999]	This is the system password, which must correspond to the password entered with P20. Standard: 66.
P23	Lock Function [OFF, ON]	This function allows the user to disable or enable parameter entry in the main menu. If set to ON, enter the password P20 to change the parameters. Standard: ON.







4.6.3 Drive configuration parameters





No.	Parameters	Measurement unit	Comments
P25	Control mode [ACT, HCS, MSE, MSY]		This parameter is used to set the control mode (default value: HCS).
			ACT: Actuator mode. A single centrifugal pump always runs at a certain speed at each delivery rate. ACT always tries to minimise the difference between the speed set point and the actual motor speed. When a 0-10V signal arrives at terminals 7 and 8, the centrifugal pump automatically switches to ACT mode according to the external signal as shown in Fig. D-4. If the external signal is missing, the centrifugal pump remains in ACT mode and uses the value entered on the display as the set point.

* Depending on the pump type used

No.	Parameters	Measurement unit	Comments
			<p>HCS: Hydrovar control mode for the single centrifugal pump. The centrifugal pump maintains a constant pressure at each delivery rate: The Hydrovar algorithm based on the input of parameters P26 to P37 is implemented.</p> <p>The HCS mode must be set in conjunction with an absolute pressure sensor installed in the hydraulic circuit, which gives the unit the pressure feedback signal: HCS always tries to minimise the difference between the pressure set point and the pressure feedback signal.</p>
			<p>MSE: Hydrovar control mode for multi-pump systems in serial cascade. The centrifugal pumps are connected in series: Only the last activated centrifugal pump modulates the speed to the set pressure, while all other centrifugal pumps in operation run at maximum speed.</p> <p>The various centrifugal pumps connected to each other via the multi-pump protocol maintain a constant pressure at each delivery rate: The Hydrovar algorithm based on the input of parameters P26 to P37 is implemented.</p> <p>The MSE mode must be set in conjunction with absolute pressure sensors, one per centrifugal pump, which provide the pressure feedback signal to the centrifugal pump unit: MSE always tries to minimise the difference between the pressure set point and the pressure feedback signal. When using the multi-pump protocol, up to 3 centrifugal pumps of the same type and capacity can be connected.</p>
			<p>MSY: Hydrovar control mode for multi-pump systems in synchronous cascade. The centrifugal pumps are synchronised: They all maintain the set pressure and run at the same speed. Other properties as in MSE mode.</p>
P26	Max RPM set [ACT set=Max*Rotational speed setting [ACT set – Max.]] 	rpmx10	Adjustment of the max. centrifugal pump speed.

* Depending on the pump type used

No.	Parameters	Measurement unit	Comments
P27	Min RPM set [Min*÷ACT set] 	rpmx10	Adjustment of the min. centrifugal pump speed.
P28	Ramp 1 [1÷250] 	s	This parameter controls the time for fast acceleration. The centrifugal pump control in HCS, MSE and MSY mode is affected. Standard: 3 s.
P29	Ramp 2 [1÷250] 	s	This parameter controls the time for the fast deceleration. The centrifugal pump control in HCS, MSE and MSY mode is affected. Standard: 3 s.
P30	Ramp 3 [1÷999] 	s	This parameter controls the slow acceleration. It determines: <ul style="list-style-type: none"> the Hydrovar adjustment speed with small changes in delivery rate. the constant outlet pressure. The ramp depends on the system to be controlled and influences the centrifugal pump control in HCS, MSE and MSY mode. Standard: 35 s.
P31	Ramp 4 [1÷999] 	s	This parameter controls the time for the slow deceleration. Other characteristics: same as for ramp 3.
P32	Ramp Speed Min Acceleration [2.0÷25.0] 	s	This parameter determines the time for the fast acceleration. It represents the acceleration ramp used by the Hydrovar control until the centrifugal pump reaches its minimum rotational speed (P27). The centrifugal pump control in HCS, MSE and MSY mode is affected. Standard: 2.0 s.
P33	Ramp Speed Min Deceleration [2.0÷25.0] 	s	This parameter determines the time for the fast deceleration. It represents the deceleration ramp used by the Hydrovar control until the centrifugal pump stops when it reaches its minimum rotational speed (P27). The centrifugal pump control in HCS, MSE and MSY mode is affected. Standard: 2.0 s.







No.	Parameters	Measurement unit	Comments
P34	Speed Min Configuration [STB, SIM] 		<p>This parameter determines the behaviour of the Hydrovar speed control as soon as the minimum rotational speed of the centrifugal pump (P27) is reached:</p> <p>STB (STP): As soon as the specified pressure has been reached and there is no further demand, the centrifugal pump speed drops to the selected value P27: Hydrovar continues to run according to the selected time period (P35) and then stops automatically.</p> <p>SIM (SMI): As soon as the specified pressure has been reached and there is no further demand, the centrifugal pump speed drops to the selected value P27: Hydrovar continues to run at the same speed. This parameter influences the centrifugal pump control in HCS, MSE and MSY mode.</p> <p>Standard: STB</p>
P35	Smin time [0÷100] 	s	<p>This parameter is used to enter a time delay before switching off under P27. Used by Hydrovar speed control only with P34 = STB.</p> <p>The centrifugal pump control in HCS, MSE and MSY mode is affected.</p> <p>Standard: 0 s.</p>
P36	Window [0÷100] 	%	<p>This parameter is used to enter the ramp control interval as a percentage of the pressure set point. It is used to determine the pressure range near the set point where the Hydrovar speed control uses slow acceleration and deceleration ramps instead of fast ones. The centrifugal pump control in HCS, MSE and MSY mode is affected.</p> <p>Standard: 10%.</p>
P37	Hysteresis [0÷100] 	%	<p>This parameter specifies the hysteresis for the slow ramp as a percentage of P36. It is used to determine the pressure range near the set point at which the Hydrovar speed controller moves from the slow acceleration ramp (P28) to the slow deceleration ramp (P29).</p> <p>This parameter influences the centrifugal pump control in HCS, MSE and MSY mode.</p> <p>Standard: 80%.</p>

No.	Parameters	Measurement unit	Comments
P38	Speed Lift [0÷MAX*]	rpmx10	This parameter determines the speed limit after which the linear increase of the actual value (P02) starts and continues until the total increase (P39) to the maximum speed (P26). Standard: P27.
P39	Lift Amount [0÷200]	%	This parameter determines the increase in the actual value (P02) to the maximum speed (P26), measured as a percentage of the specified value (P01). It determines the increase in the preset pressure setting, which is used to compensate for flow resistance at high delivery rates. Standard: 0.

4.6.4 Sensor configuration parameters

No.	Parameters	Measurement unit	Comments
P41	Pressure Sensor Unit Of Measure [BAR, PSI]	bar/psi	This parameter is used to set the measuring unit (BAR, PSI) for the pressure sensor. It affects the parameter for the LED display (refer to chapter D-4.4.4). Standard: BAR.
P42	Pressure Sensor Full Scale - 4÷20 mA [0.0÷25.0BAR] / [0.0÷363PSI]	bar/psi	This parameter determines the full scale value of the pressure sensor 4÷20 mA connected to analog inputs 9 and 10. Standard: depending on the type of centrifugal pump used.
P44	Zero Pressure Auto-Calibration	bar/psi	This parameter allows the user to perform the initial auto-calibration of the pressure sensor. It is used to compensate the offset signal of the sensor at zero pressure due to the tolerance of the sensor. Procedure: At 0 pressure of the hydraulic system (no water contained) or when the pressure sensor is disconnected from the pipes, switch to P44: the actual value for 0 pressure is displayed. Start the auto-calibration by pressing or (refer to chapter D-4.3). When the auto-calibration is completed, the 0 (zero) pressure or the signal "---" (---) is displayed if the sensor signal is outside the permissible tolerance range.





* Depending on the pump type used





No.	Parameters	Measurement unit	Comments
P45	Pressure Minimum Threshold [0÷42] 	bar/psi	Setting the minimum pressure limit value. If the system pressure drops below this limit value over the time set with P46, the low-pressure error E14 occurs. Standard: 0 bar.
P46	Pressure Minimum Threshold – Delay Time [1÷100] 	s	Setting the delay time. This parameter is used to set the delay time during which the unit runs empty at a system pressure below P45 before the low-pressure error E14 occurs. Standard: 2 s.
P47	Pressure Minimum Threshold – Automatic Error Reset [OFF, ON] 		Activation/deactivation attempts of the automatic unit in case of a low-pressure error. Standard: ON.
P48	Lack Of Water Switch Input [DIS, ALR, ERR]		This parameter activates/deactivates the control of the low water input (refer to chapter D-3.6, terminals 13 and 14). It determines the behaviour of the unit when the low water input is activated and the switch is open:  (DIS): The unit does not process the information coming from the "water shortage" input.  (ALr): The unit reads the "low water" input (activated) and reacts when the switch is opened by indicating the corresponding alarm A06 on the display, while the motor continues to run.  (Err): The unit reads the "low water" input (activated) and reacts when the switch is opened by stopping the motor and generating the corresponding error E11. The error condition is then exited when the switch closes again and the motor restarts. Standard: ERR.

4.6.5 RS485 interface parameters

No.	Parameters	Measurement unit	Comments
P50	Communication protocol [MOD, BAC]		This parameter is used to select the protocol on the communication port: <ul style="list-style-type: none"> • NOD (MOD): Modbus RTU • BAC (BAC): BACnet MS/TP. Standard: MOD.
P51	Communication protocol – Address [1÷247]/[0÷127]		Depending on the protocol selected in P50, this parameter is used to enter the desired address for the unit when it is connected to an external device: <ul style="list-style-type: none"> • MOD: each value in the range 1-247 • BAC: any value in the range 0-127.
P52	Comm Protocol – BAUDRATE [4.8, 9.6, 14.4, 19.2, 38.4, 56.0, 57.6 KBPS]	kbps	This parameter determines the desired baud rate for the communication port. Standard: 9.6 kbps.
P53	BACnet Device ID Offset [0÷999]		This parameter is used to enter the hundreds, tens and ones of the BACnet device ID. Standard: 002. Default device ID: 84002.
P54	Comm Protocol – Configuration [8N1 , 8N2 , 8E1 , 8o1]		This parameter is used to enter the length of the data bits, the parity and the length of the stop bits.

4.6.6 Multi-pump configuration parameters

No.	Parameters	Measurement unit	Comments
P55	Multipump – Address (Multipump – Address) [1÷3]		This parameter determines the address of each centrifugal pump based on the following criteria: Each centrifugal pump needs its own pump address (1 - 3). Each address can only be assigned once. Standard: 1.
P56	Multipump – Max Units [1÷3] 		This parameter determines the maximum number of centrifugal pumps that can operate simultaneously. Standard: 3.
P57	Multipump – Switch Interval [0÷250] 	h	This parameter determines the switching interval for the automatic switching of the MAIN PUMP and the auxiliary pumps. As soon as the specified time has elapsed, the next centrifugal pump becomes the MAIN PUMP and the counter starts again. This ensures a balanced distribution of operating hours among all centrifugal pumps. Standard: 24 h.
P58	Multipump – Actual Value Increase [0.0÷25.0 BAR] / [0.0÷363PSI] 	bar/psi	This parameter influences the calculation of P02 to improve the multi-pump control, as described in chapter D-4.7.2. Standard: 0.35 bar.
P59	Multipump – Actual Value Decrease [0.0÷25.0 BAR] / [0.0÷363PSI] 	bar/psi	This parameter influences the calculation of P02 to improve the multi-pump control, as described in chapter D-4.7.2. Standard: 0.15 bar.
P60	Multipump – Enable Speed [P27-P26] 	rpmx10	This parameter specifies the speed that a centrifugal pump must reach before the next auxiliary pump starts after a system pressure drop below the differential value between P02 and P59. Standard: depending on the type of centrifugal pump used.

No.	Parameters	Measurement unit	Comments
P61	Multipump Synchronous – Speed Limit [P27-P26] 	rpmx10	This parameter is used to enter the speed limit at which the first auxiliary pump stops when the speed falls below this limit. Standard: depending on the type of centrifugal pump used.
P62	Multipump Synchronous – Window [0-100] 	rpmx10	This parameter is used to enter the speed limit for stopping the next auxiliary pump. Standard: 150 rpmx10.
P63	Multipump – Priority 		This parameter represents the priority value of the centrifugal pumps in a multi-pump system. This parameter displays the following information: Pr1 (Pr1) .. Pr3 (Pr3) or Pr0 (Pr0) In this case: Pr1 .. PR3 indicates that the centrifugal pump communicates with other centrifugal pumps and that its priority order corresponds to the number displayed. Pr0 indicates that the centrifugal pump does not detect any communication with other centrifugal pumps and is detected as stand-alone in the multi-pump bus.
P64	Multipump – Revision 		This parameter displays the revision value used in the multi-pump protocol.

4.6.7 Test run configuration parameters

No.	Parameters	Measurement unit	Comments
P65	Test Run – Time Start (Test run – Start time) [0-100]	h	This parameter is used to set the time that must elapse after the last centrifugal pump stop for a test run to be started. Standard: 100 h.
P66	Test Run – Speed (Test run – Rotational speed) [Min-Max]	rpmx10	This parameter specifies the pump rotational speed for the test run. The minimum and maximum rotational speed depends on the centrifugal pump type. Standard: 200 rpmx10.
P67	Test Run – Time Duration [0-180]	s	This parameter specifies the duration of the test run. Standard: 10 s.

4.6.8 Special parameters

No.	Parameters	Measurement unit	Comments
P68	Default Values Reload ,		If set to RES, this parameter causes a return to the factory settings after its confirmation and the default parameter values are reloaded.
P69	Avoid Frequently Parameters Saving [NO, YES]		This parameter reduces the frequency at which the unit stores the required value P02 in the EEPROM memory to extend its lifetime. This can be particularly advantageous for applications with BMS control units, as they require constant value changes for fine adjustment. Standard: NO.

4.7 Technical references

4.7.1 Example: ACT control mode with analog input 0-10V

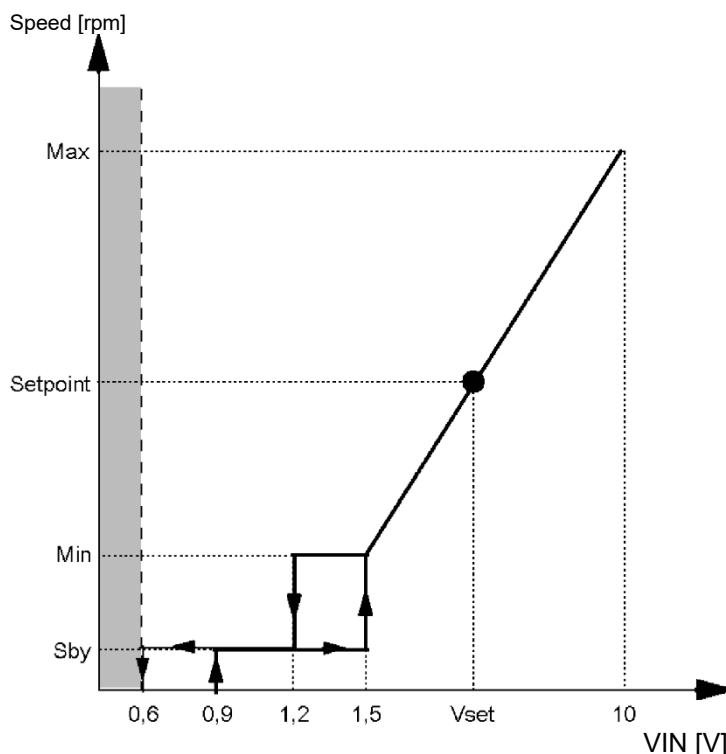
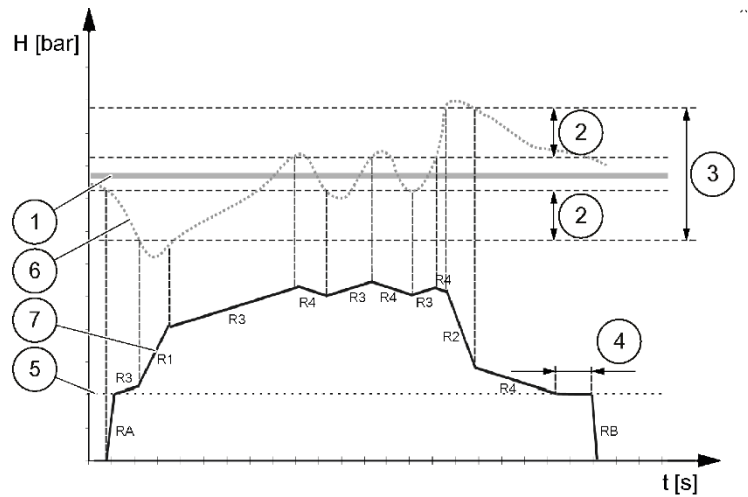

Fig. D-4: ACT control mode diagram

Display	Comments
Grey area	Limit value input voltage detection missing:
Speed in rpm	Actual speed related to the analog input voltage value 0-10 V refer to chapter D-3.6, contacts 7 and 8):
Max	P26 (max. RPM setting):
Min	P27 (min. RPM setting):
Index value	Example: actual speed in relation to a specific Vset voltage value.
Sby	Input voltage at which the motor goes into standby.
Vin in V	Input voltage value to control the centrifugal pump in ACT mode. (Various limit values are controlled by the centrifugal pump, from non-detection to maximum speed.)
For more information on the control mode and ACT setting parameters, refer to chapter D-4.6.3.	

4.7.2 Example: Ramp setting



- ① P01 (required value)
- ② P37 (control hysteresis) in % of P36 (setting window)
- ③ P36 (setting window) in % of P01 (required value)
- ④ P35 (minimum rotational speed – duration)
- ⑤ P27 (minimum speed)
- ⑥ Actual delivery head
- ⑦ Actual speed
- RA P32 (acceleration ramp at startup)
- RB P32 (deceleration ramp on switch-off)
- R1 P28 (ramp 1) – Fast acceleration ramp
- R2 P29 (ramp 2) – Fast deceleration ramp
- R3 P30 (ramp 3) – Slow acceleration ramp
- R4 P31 (ramp 4) – Slow deceleration ramp

Fig. D-5: Ramp settings

For more information on the control mode and ACT setting parameters, refer to chapter D-4.6.3

4.7.3 Required RMS value (example)

Activation of centrifugal pumps in cascade mode

1. Control centrifugal pump reaches P60 (activate speed).
2. Actual value drops to the switch-on value of the first auxiliary pump. First auxiliary pump switches on automatically. (Switch-on value = P01 (required value) – P59 (actual value reduction)).
3. New required value, P02 (actual required value) is calculated after start.

Calculation of the actual required value in cascade mode serial (MSE)

K = Number of active centrifugal pumps.

Pr = Priority of centrifugal pumps.

$P02$ (actual required value) = $P01$ (required value) + $(K - 1) * P58$ (actual value increase) - $(Pr - 1) * P59$ (actual value reduction)

Calculation of the actual required value in cascade synchronous operating mode (MSY)

K = Number of active centrifugal pumps ($K \geq Pr$).

$P02$ (actual required value) = $P01$ (required value) + $(K - 1) * (P58 - P59)$.

Behaviour of P58 (actual value increase) and P59 (actual value reduction)

- If $P58$ (actual value increase) = $P59$ (actual value reduction)
→ Pressure constant, irrespective of the number of centrifugal pumps in operation.
- If $P58$ (actual value increase) > $P59$ (actual value reduction)
→ Pressure increases when the auxiliary pump starts.
- If $P58$ (actual value increase) < $P59$ (actual value reduction)
→ Pressure decreases when the auxiliary pump starts.

4.8 Troubleshooting

4.8.1 Alarm codes

Code	Designation	This is the cause
A03	Loss of power	Temperature too high
A05	Data memory alarm	Data memory corrupted
A06	LOW alarm	Detection of water shortage (if P48 = ALR)
A15	EEPROM write error	Data memory corrupted
A20	Internal alarm	
A30	Multiple pump connection alarm	Incorrect multi-pump connection
A31	Loss of multi-pump connection	Loss of multi-pump connection

4.8.2 Error codes

Code	Designation	This is the cause
E01	Internal communication error	Lack of internal communication
E02	Motor overload error	High motor current
E03	DC-bus overvoltage error	DC-bus overvoltage
E04	Error running control	Motor standstill
E05	EEPROM data memory error	EEPROM data memory corrupted
E06	Lattice voltage error Mains voltage error	Voltage supply outside operating range
E07	Error motor winding temperature	Thermal contactor motor tripped
E08	Power module temperature error	Thermal contactor frequency converter tripped
E09	General hardware error	Hardware error
E10	Dry-run error	Dry-run detection
E11	LOW error	Detection of water shortage (if P48 = ERR)
E12	Pressure sensor error	Missing pressure sensor (not available for ACT)
E14	Low-pressure error	Pressure below minimum limit (not available for ACT)
E30	Multi-pump protocol error	Incompatible multi-pump protocol
Refer to chapters D-4.4.2 and 4.5.3		

E Commissioning



Caution! The power supply of the system must not be connected/switched on until the centrifugal pump has been filled and vented. Danger of the centrifugal pump running dry due to air entrapment.



Caution! The closing cap at the gas filling valve of the diaphragm expansion tank has a sealing function and needs to be tightened following the adjustment of the inlet pressure.

Commissioning activities

1. Switch off the operating switch on the pressure booster system.
2. Connect shut-off valves (suction/pressure side) to the pressure booster system.
3. Close the drain (refer to Fig. D-1).
4. Fill the centrifugal pump at the filling opening.
5. Slowly open shut-off valves on the suction side of the pressure booster system.
6. Connect the system power supply, switch on (the centrifugal pump starts and pressure is built up).
7. Slowly open the shut-off valves in the water drain of the system and vent the downstream installation at a withdrawal point.

Pressure booster system GENO-FU-X

Check the target pressure (operating pressure) at the operating panel. If necessary, the preload pressure at the diaphragm expansion tank must be adjusted (refer to chapter E-2).

For double systems, the target pressure (operating pressure) must be set for each centrifugal pump in manual mode.

Pressure booster system GENO-HR-X

Check the switch-on pressure and adjust as described in chapter E-3 if necessary.

8. Test dry-run protection (float or pressure switch).
9. Check the system in general for tightness by means of a visual check.

1 | Installation of pressure booster systems

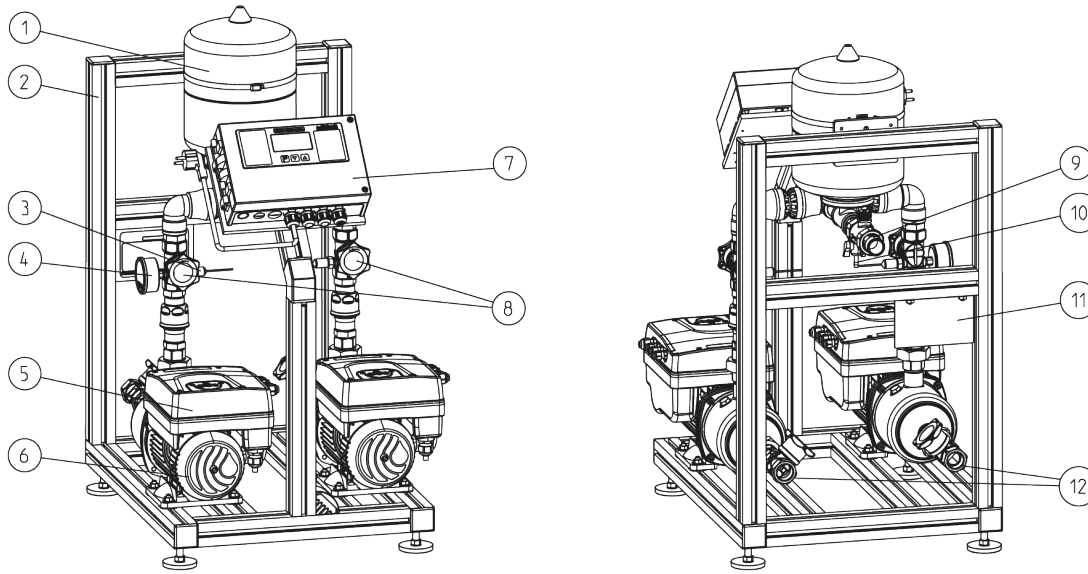

- | | | |
|----------------------------|--------------------------------|------------------------------|
| ① Diaphragm expansion tank | ⑤ Frequency converter | ⑨ Contact water meter output |
| ② System rack | ⑥ Centrifugal pump | ⑩ Draining valve |
| ③ Pressure sensor | ⑦ Control unit | ⑪ Type plate |
| ④ Pressure gauge | ⑧ Shut-off valve pressure side | ⑫ Shut-off valve inlet |

Fig. E-1: Installation of pressure booster system GENO-FU-X 2/40-2 N

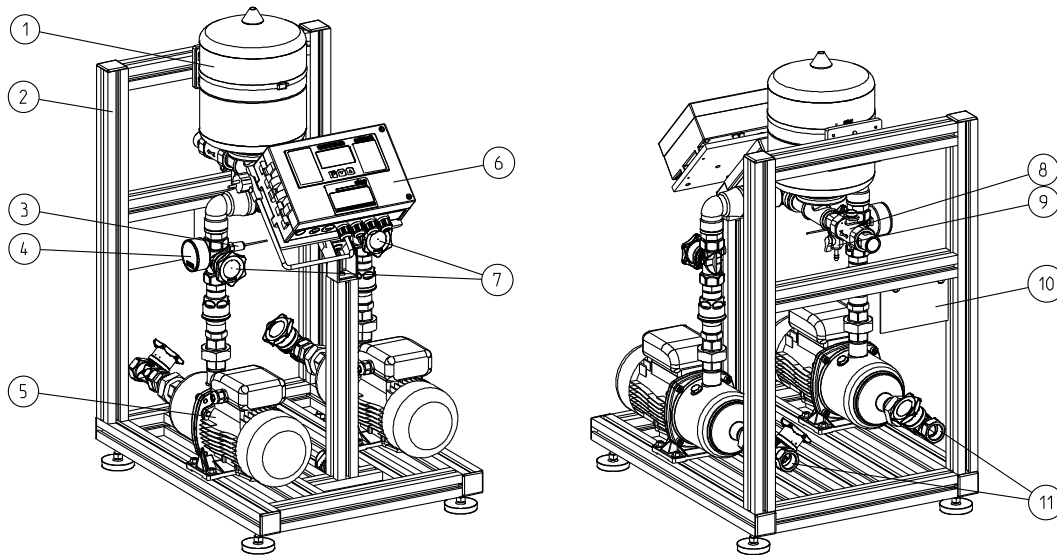

- | | | |
|----------------------------|--------------------------------|------------------------|
| ① Diaphragm expansion tank | ⑤ Centrifugal pump | ⑨ Draining valve |
| ② System rack | ⑥ Control unit | ⑩ Type plate |
| ③ Pressure switch | ⑦ Shut-off valve pressure side | ⑪ Shut-off valve inlet |
| ④ Pressure gauge | ⑧ Contact water meter output | |

Fig. E-2: Installation of pressure booster system GENO-HR-X 2/40-2 N

2 | Adjustment of target pressure (operating pressure) for pressure booster systems GENO-FU-X

A change in the target pressure (operating pressure) requires an adaptation of the diaphragm expansion tank. Changes must be indicated on the pressure booster system and documented in the operation log.

The diaphragm expansion tank is preset to 4 bar preload pressure at the factory. In order to ensure the correct operation of the centrifugal pump, the diaphragm expansion tank must be adjusted to a preload pressure which corresponds to 90% of the centrifugal pump set point (operating pressure).

The preload pressure must be checked and adjusted with an empty diaphragm expansion tank without pressure on the water side. Nitrogen with approval according to DVGW (German Association of the Gas and Water Industry) must be used as filling gas.

The target pressure (operating pressure) is set by the $\boxed{+}$ / $\boxed{-}$ button on the operating panel of the frequency converter of the centrifugal pump (refer to chapter D-4.1, D-4.2, D-4.3).

Always target pressure values (operating pressure) which correspond to the delivery characteristic curve range of the centrifugal pump.

3 | Adjustment of switch-on pressure for pressure booster systems GENO-HR-X

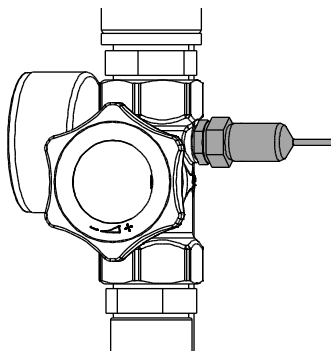

Fig. E-4: Pressure switch
GENO-HR-X

The diaphragm expansion tank is factory-set with a preload pressure of 2.5 bar. The preload pressure can be adjusted depending on the customer's consumption conditions (refer to chapter E-2).

The level of the preload pressure depends largely on:

- Accepted volume flow
- Pressure to be supplied
- On/off switching cycles
- Pipe network resistance values

The diaphragm pressure switch has a central adjusting screw.

The switch-on pressure can be adjusted at this adjusting screw (factory setting 4.0 bar).

Increasing the switch-on pressure

The switch-on pressure can be increased by screwing in the adjusting screw.

Reducing the switch-on pressure

The switch-on pressure can be reduced by unscrewing the adjusting screw.

F Operation

1 | Preface

The pressure booster systems GENO-FU and GENO-HR are operated and monitored via the PBS control system.

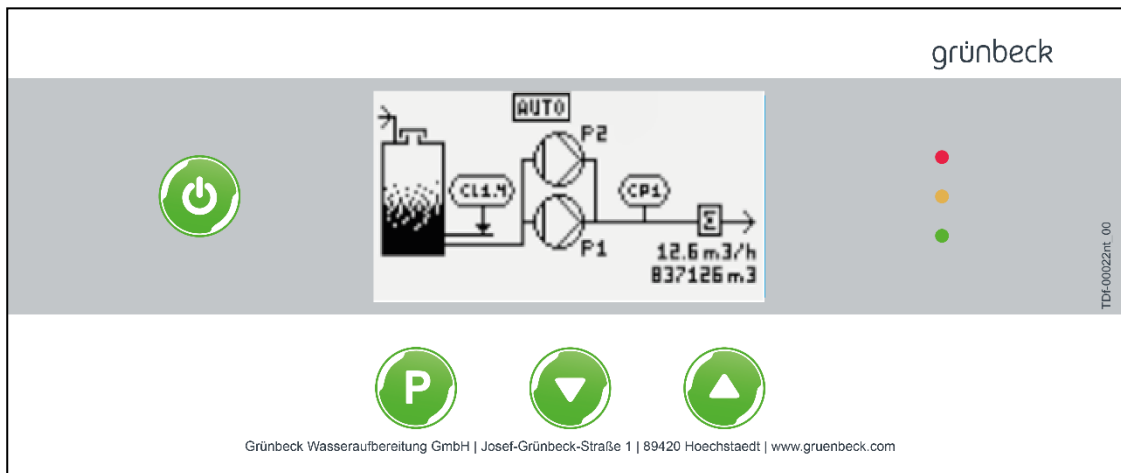

2 | How to operate the control unit

2.1 Key function

Key/ combination	Function
	<ul style="list-style-type: none"> • Accesses parameters for editing (cursor flashing). • Save the modified parameters (cursor stops flashing). • Starting from basic display (actual flow rate / total water quantity): Press and hold for > 1 sec. = access to the operator menu. • Acknowledge of errors/warnings.
	<ul style="list-style-type: none"> • Within a menu: Switch to the next parameter. • Opened parameters: Reduce the set value.
	<ul style="list-style-type: none"> • Within a menu: Return to the previous parameter. • Opened parameters: Increase the set value.
+	<ul style="list-style-type: none"> • Starting from basic display (actual flow rate / total water quantity): Access to the code request for menu levels with code protection.
+	<ul style="list-style-type: none"> • Jump back to the basic display from each menu level (actual flow rate / total water quantity). • Close the opened parameter without saving, the previously set value is maintained.
	<ul style="list-style-type: none"> • Switch the system on/off in the selected operating mode.

5 minutes after the last key operation, the display returns from each open menu back to the basic display (actual flow rate / total water quantity). Parameter changes which have not been saved are lost.

The display backlighting is switched off 10 minutes after the last key was pressed. Each new key press activates the backlighting again.

2.2 Meaning of the LEDs
red / yellow / green

Green LED (bottom) lights up = everything OK.

Yellow LED (middle) lights up = signal (service due, dry-run protection, ext. operational release missing, power failure > 24 h).

Red LED (top) lights up = fault.

Also refer to chapter G Faults.

2.3 Reading the state

The info level offers the following information about operation of the system. Depending on whether one or two centrifugal pump units are available, either only P1 or P1 and P2 are shown.

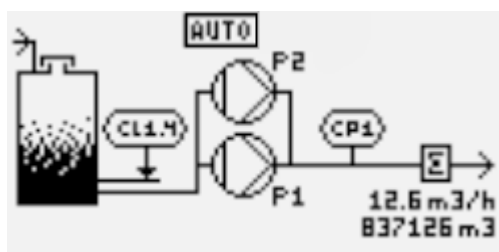

Selected operating mode

Current flow rate

Total water quantity (registered by water meter)

Press the ▼ key to continue or the ▲ key to go back

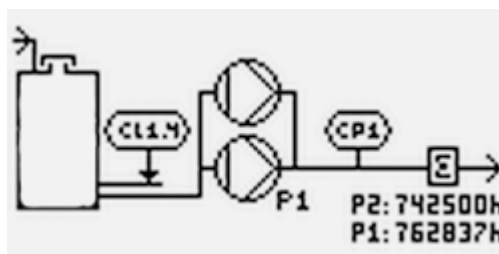

Operating hours aggregate P1

Operating hours aggregate P2 (if available)

2.4 System status display

- When the pump is in operation, the water flow is displayed as "flowing".
- When dry-run protection is applied, the tank is displayed empty.
- The pressure switch symbol CP1 is not available for system type FU.

2.5 Setting operating parameters – operator menu

- During commissioning, at least the desired operating mode must be programmed (refer to table below, printed in bold type).
- Starting point: Basic display (actual flow rate / total water quantity).

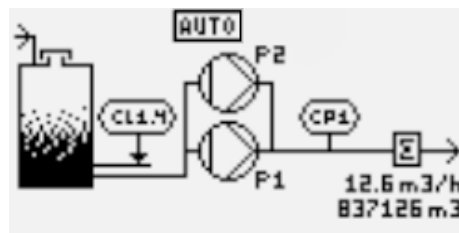

Press and hold P key for > 1 sec. >> Operator menu appears:

Parameters	Factory setting	Setting range	Comments
Operating mode	Off	Off / Manual P1 / Manual P2 / Auto / Bus.	<p>Manual P2 is only available for double pressure booster systems.</p> <p>Auto is only available for the pressure booster systems GENO-HR-X and for double pressure booster systems.</p> <p>Manual Px = The centrifugal pump runs – depending on the water withdrawal – until the operating mode is changed or a malfunction occurs. In case of double pressure boosters, there is no automatic switchover to the other centrifugal pump.</p> <p>Auto = The centrifugal pump runs – depending on the water withdrawal – until there is a switchover to the other centrifugal pump due to a time interval. An automatic fault changeover also takes place.</p> <p>Bus = Automatic + signal "Request system" the centrifugal pumps run depending on the signal "Request system"</p>

Parameters	Factory setting	Setting range	Comments
Data logging	No	No/Yes	On internal SD card (*), card slot on operating board Tim interval for data logging
Interval min.	60	1 ... 999	
Language	German	German / English / French / Dutch / Italian / Spanish / Russian	
Time	XX:XX	00:00 ... 23:59	Only relevant if data logging is active.
Date	XX.XX.XXXX		

(*) The Yes setting means the following information is recorded in the set interval:

- Operating state (Off / Manual P1 / Manual P2 / Automatic).
- Current flow (Q XX.XX m³/h).
- Operating hours (P1 XXXXXX h, P2 XXXXXX h).
- Total water quantity (V XXXXXX m³).
- Time until service is due (S XXX d).

The data is stored on the SD card as a *.txt file, the values are separated from one another by semicolons. This means the file can be imported into MS Excel, for example, without difficulty.



Caution! Prior to removing the SD card, make sure that the data logging was terminated with "No"!



Note: The SD card used must be formatted FAT32. We recommend proper formatting instead of quick formatting.



Note: When the SD card is full, a warning appears in the control unit

G Troubleshooting

1 | Basic information

Even carefully designed and manufactured technical systems that are operated properly, may experience malfunctions. The tables below provide an overview of possible problems that can occur during the operation of the device and indicates the causes and their elimination.



Required interventions are only allowed to be performed by qualified electrical experts according to the VDE guidelines or according to the guidelines of similar local institutions.



Required interventions on a pressure booster system represent a major interference with the drinking water system and therefore are only allowed to be performed by authorised installation companies.



Warning! Prior to testing or dismantling pressurised components, depressurise said components.

Disconnect the system from the power supply as otherwise it might start running during the troubleshooting.



Warning! The instructions in chapter D Installation and chapter E Commissioning must also be observed when interventions are necessary. You will also find detailed information on the centrifugal pump there.



Note: In case of disturbances that you cannot remedy yourself, please contact your local Grünbeck service/Grünbeck's authorised service company (www.gruenbeck.com).

2 | Troubleshooting on the SM drive system (centrifugal pump with frequency converter)

Failure due to "lack of water during suction"

If the standstill was caused by lack of water in the feed tank, the system only starts automatically provided the operation is enabled by the float/pressure switch (if there is enough water available in the tank).

Failure due to other causes (except "lack of water during suction")

In all other cases, the system resumes operation automatically after 20 seconds. If the cause for the failure remains, the system definitely stops after three start attempts.

In order to reset this situation, the system has to be disconnected from power for approximately one minute.

Should at least 10 minutes elapse without any further disturbance following an alarm, the alarm counter is reset and another three start attempts are possible.

If two or more alarm situations occur at the same time (e. g. overtemperature of the motor and lack of water), only the alarm that is the first to transfer the corresponding signal to the monitoring card will be indicated.

Table G-1: Rectifying faults (GENO-FU-X)

This is what you observe	This is the cause	This is what to do
System is switched off.	Voltage supply not connected.	Re-establish voltage.
	Switch to OFF.	Set switch to ON.
The motor does not start.	Power supply not connected.	Connect the power supply
	Triggering of the motor overload protection.	Rectify fault and reset switch.
	Motor defective.	Repair or replace the motor.
Frequent starts and stops.	Diaphragm expansion tank defective.	Repair or replace the diaphragm expansion tank.
	Wrong preload pressure of the diaphragm expansion tank.	Set the correct preload pressure of the diaphragm expansion tank.
	Feed tank is empty.	The tank must be filled.
The centrifugal pump speed increases and decreases without stopping and without water consumption (consumer closed).	Water losses through the non-return valve.	Check hydraulic system and replace valve if necessary.
	Too small or damaged diaphragm expansion tank.	Repair or replace the diaphragm expansion tank.
The motor is running, but no water is being pumped.	No water on the suction side or in the centrifugal pump.	Fill the centrifugal pump or suction line Open the on/off valves.
	Air in suction line or centrifugal pump.	Bleed the centrifugal pump, check the suction connections.
	Pressure loss on the suction side.	Check the NPSH and change the system if necessary.
	Shut-off valve blocked.	Clean valve.
	Line blocked.	Clean the line.
Loss of water at the centrifugal pump.	Mechanical seal defective.	Replace the mechanical seal.
	Excessive mechanical stress on the centrifugal pump.	Support the lines.
Centrifugal pump very noisy.	The water runs back when the centrifugal pump is at a standstill.	Check the non-return valve.
	Cavitation	Check suction.
	Centrifugal pump rotation blocked.	Excessive mechanical load on the centrifugal pump → check.
	The water runs back when the centrifugal pump is at a standstill.	Check the non-return valve.

Table G-1: Rectifying faults continuation (GENO-FU-X)		
This is what you observe	This is the cause	This is what to do
The unit does not generate the desired pressure.	Incorrect direction of rotation of the centrifugal pump.	Check the correct connection of the motor by exchanging the two lines.
	On/off valves closed.	Open the valves.
	Air in the suction line.	Discharge air. Fill the centrifugal pumps.
	Suction height too high.	Reduce the suction height.
	Excessively high suction-side flow resistance.	Use a suction pipe with a larger diameter.
	Foot valve defective.	Replace the foot valve.
	Too high flow resistance in the pressure pipes or valves, or both.	Reduce pressure losses.
Triggering of the general protection system (fuses).	Short circuit.	Check the connection cable. Check the motor.
Tripping of the residual current circuit breaker.	The motor is damaged.	Replace the motor.
	The motor power cable is defective or worn.	Replace the cable.
	The residual current circuit breaker does not conform to the specifications.	Replace the circuit breaker.
	Fault current too high.	Contact a qualified electrician to adjust the electrical system.
The centrifugal pump runs at maximum speed without stopping.	The pressure set point does not correspond to the system (= higher than the value available from the centrifugal pump).	Set a new set point according to the centrifugal pump performance.
	The sensor is not connected or is defective.	Check the hydraulic and electrical connections of the sensor.
A single centrifugal pump operates	The centrifugal pumps are set differently.	Check the frequency converter settings. Check settings of peak capacity Check water meter
Water is requested, but no centrifugal pump starts.	The set point is zero.	Check the frequency converter settings. Adjust the set point correctly.

3 | Warnings, faults on PBS control unit

Table G-3: Warnings		
This is what you observe	This is the cause	This is what to do
Maintenance interval.	Maintenance interval of the pressure booster has expired.	Notify Grünbeck's technical customer service/authorised service company.
Ext. Operational release missing.	Voltage-free contact from on site is opened.	Check wiring.
Dry-run protection BB1 CL1.4.	Insufficient water in the collection tank.	The signal is self-acknowledging as soon as sufficient water is available again.

4 | Errors

Table G-4: Errors		
This is what you observe	This is the cause	This is what to do
System type GENO-FU-X		
Fault P1	The frequency converter alarm relay is open.	Refer to the following description of the control LEDs on the centrifugal pump unit.
Fault P2		Only with double pressure booster system.
System type GENO-HR-X		
Fault P1	After the centrifugal pump starts, the minimum flow rate is not exceeded after a delay time has elapsed and no pressure has been built up.	If the fault occurs again after acknowledgement, please notify Grünbeck's technical service/authorised service company. Check water meter Check pressure switch
Fault P2		Only for double pressure booster systems.

H Inspection, maintenance

1 | Basic information

In order to ensure the trouble-free operation of pressure booster systems in the long term, some regular work is necessary. In particular when it comes to pressure booster systems in the drinking water supply, the required measures are defined in the pertinent regulations and guidelines. All regulations and guidelines, which apply at the installation site must be strictly adhered to.

Inspection and maintenance on the basis of DIN 1988, part 8.

- Inspections have at least to be performed every 2 months by the operator or an installation company.
- Maintenance work must be carried out at least once a year by an approved installation company or by Grünbeck's technical service/authorised service company.



Required interventions on electrical components are only allowed to be performed by qualified electrical experts according to the VDE guidelines or according to the guidelines of similar local institutions.



Required interventions on a pressure booster system represent a major interference with the drinking water system and therefore are only allowed to be performed by authorised installation companies.



Note: A maintenance contract ensures that all the required maintenance work will be performed in due time.



Note: Should you detect any malfunctions during inspection or maintenance, please refer to chapter E – Troubleshooting – for remedies.

2 | Inspection



Note: If you find a fault during the inspection, please inform an approved installation company or Grünbeck's technical service/authorised service company (refer to www.gruenbeck.com).

Inspection work

- Check system for damage.
- Check the system in general for tightness by means of a visual check.
- Record the inspection in the operation log.

3 | Maintenance



Danger due to electrical energy!

Prior to any intervention, make sure that all electrical connection (even those without voltage) are de-energised.



Danger due to electrical energy!

Prior to any work on the system's electrical or mechanical components, disconnect the centrifugal pump's frequency converter from the mains supply.

Wait for at least 5 minute after disconnection from mains before carrying out any work on the frequency converter (SM drive system) to allow the capacitors in the internal circuit to discharge.



Warning! In case of required interventions and during maintenance, also observe the stipulations in chapter D Installation and start-up. You will also find detailed information on the centrifugal pump there.

Maintenance work

Diaphragm expansion tank

- Check the diaphragm expansion tank for damage and corrosion. If in doubt, replace it.
- Test the membrane: Actuate the gas filling valve briefly, if there is a water leak then replace the diaphragm expansion tank.
- Check the setting pressure (preload) of the diaphragm expansion tank and correct if necessary (refer to chapter E). Use nitrogen for gas filling. The water side must be unpressurised.

Centrifugal pump with pressure control

- The centrifugal pump with pressure control does not require normal maintenance if it is used in accordance with the intended use.

System in general

- Check system for damage.
- Check the tightness of the non-return valve and replace if necessary.
- Check the setting pressure (operating pressure) of the centrifugal pump on the pressure gauge and readjust if necessary (refer to chapter E).
- Test dry-run protection.
- Check the system in general for tightness by means of a visual check.
- Enter maintenance and, if necessary, repairs in the operation log.

4 | Operation log

Customer

Name:

Address:

.....

.....

Pressure booster system
GENO-FU-X

2/40-1 N

2/40-2 N

4/40-1 N

4/40-2 N

2/40-1 NE

2/40-2 NE

4/40-1 NE

4/40-2 NE

Pressure booster system
GENO-HR-X

2/40-1 N

2/40-2 N

4/40-1 N

4/40-2 N

(Please check appropriate box)

Serial number

Installed by

Proof report for inspection, maintenance and repair work Pressure booster system GENO-FU-X/GENO-HR-X		
Work performed	Execution confirmed	
<input type="checkbox"/> Inspection Description: <input type="checkbox"/> Maintenance <input type="checkbox"/> Repair	Company: Name: Date/ Signature:	
<input type="checkbox"/> Inspection Description: <input type="checkbox"/> Maintenance <input type="checkbox"/> Repair	Company: Name: Date/ Signature:	
<input type="checkbox"/> Inspection Description: <input type="checkbox"/> Maintenance <input type="checkbox"/> Repair	Company: Name: Date/ Signature:	
<input type="checkbox"/> Inspection Description: <input type="checkbox"/> Maintenance <input type="checkbox"/> Repair	Company: Name: Date/ Signature:	
<input type="checkbox"/> Inspection Description: <input type="checkbox"/> Maintenance <input type="checkbox"/> Repair	Company: Name: Date/ Signature:	
<input type="checkbox"/> Inspection Description: <input type="checkbox"/> Maintenance <input type="checkbox"/> Repair	Company: Name: Date/ Signature:	
<input type="checkbox"/> Inspection Description: <input type="checkbox"/> Maintenance <input type="checkbox"/> Repair	Company: Name: Date/ Signature:	
<input type="checkbox"/> Inspection Description: <input type="checkbox"/> Maintenance <input type="checkbox"/> Repair	Company: Name: Date/ Signature:	
<input type="checkbox"/> Inspection Description: <input type="checkbox"/> Maintenance <input type="checkbox"/> Repair	Company: Name: Date/ Signature:	

Proof report for inspection, maintenance and repair work Pressure booster system GENO-FU-X/GENO-HR-X	
Work performed	Execution confirmed
<input type="checkbox"/> Inspection Description: <input type="checkbox"/> Maintenance <input type="checkbox"/> Repair	Company: Name: Date/ Signature:
<input type="checkbox"/> Inspection Description: <input type="checkbox"/> Maintenance <input type="checkbox"/> Repair	Company: Name: Date/ Signature:
<input type="checkbox"/> Inspection Description: <input type="checkbox"/> Maintenance <input type="checkbox"/> Repair	Company: Name: Date/ Signature:
<input type="checkbox"/> Inspection Description: <input type="checkbox"/> Maintenance <input type="checkbox"/> Repair	Company: Name: Date/ Signature:
<input type="checkbox"/> Inspection Description: <input type="checkbox"/> Maintenance <input type="checkbox"/> Repair	Company: Name: Date/ Signature:
<input type="checkbox"/> Inspection Description: <input type="checkbox"/> Maintenance <input type="checkbox"/> Repair	Company: Name: Date/ Signature:
<input type="checkbox"/> Inspection Description: <input type="checkbox"/> Maintenance <input type="checkbox"/> Repair	Company: Name: Date/ Signature:
<input type="checkbox"/> Inspection Description: <input type="checkbox"/> Maintenance <input type="checkbox"/> Repair	Company: Name: Date/ Signature:
<input type="checkbox"/> Inspection Description: <input type="checkbox"/> Maintenance <input type="checkbox"/> Repair	Company: Name: Date/ Signature:

Proof report for inspection, maintenance and repair work Pressure booster system GENO-FU-X/GENO-HR-X	
Work performed	Execution confirmed
<input type="checkbox"/> Inspection Description: <input type="checkbox"/> Maintenance <input type="checkbox"/> Repair	Company: Name: Date/ Signature:
<input type="checkbox"/> Inspection Description: <input type="checkbox"/> Maintenance <input type="checkbox"/> Repair	Company: Name: Date/ Signature:
<input type="checkbox"/> Inspection Description: <input type="checkbox"/> Maintenance <input type="checkbox"/> Repair	Company: Name: Date/ Signature:
<input type="checkbox"/> Inspection Description: <input type="checkbox"/> Maintenance <input type="checkbox"/> Repair	Company: Name: Date/ Signature:
<input type="checkbox"/> Inspection Description: <input type="checkbox"/> Maintenance <input type="checkbox"/> Repair	Company: Name: Date/ Signature:
<input type="checkbox"/> Inspection Description: <input type="checkbox"/> Maintenance <input type="checkbox"/> Repair	Company: Name: Date/ Signature:
<input type="checkbox"/> Inspection Description: <input type="checkbox"/> Maintenance <input type="checkbox"/> Repair	Company: Name: Date/ Signature:
<input type="checkbox"/> Inspection Description: <input type="checkbox"/> Maintenance <input type="checkbox"/> Repair	Company: Name: Date/ Signature:
<input type="checkbox"/> Inspection Description: <input type="checkbox"/> Maintenance <input type="checkbox"/> Repair	Company: Name: Date/ Signature:

Proof report for inspection, maintenance and repair work Pressure booster system GENO-FU-X/GENO-HR-X	
Work performed	Execution confirmed
<input type="checkbox"/> Inspection Description: <input type="checkbox"/> Maintenance <input type="checkbox"/> Repair	Company: Name: Date/ Signature:
<input type="checkbox"/> Inspection Description: <input type="checkbox"/> Maintenance <input type="checkbox"/> Repair	Company: Name: Date/ Signature:
<input type="checkbox"/> Inspection Description: <input type="checkbox"/> Maintenance <input type="checkbox"/> Repair	Company: Name: Date/ Signature:
<input type="checkbox"/> Inspection Description: <input type="checkbox"/> Maintenance <input type="checkbox"/> Repair	Company: Name: Date/ Signature:
<input type="checkbox"/> Inspection Description: <input type="checkbox"/> Maintenance <input type="checkbox"/> Repair	Company: Name: Date/ Signature:
<input type="checkbox"/> Inspection Description: <input type="checkbox"/> Maintenance <input type="checkbox"/> Repair	Company: Name: Date/ Signature:
<input type="checkbox"/> Inspection Description: <input type="checkbox"/> Maintenance <input type="checkbox"/> Repair	Company: Name: Date/ Signature:
<input type="checkbox"/> Inspection Description: <input type="checkbox"/> Maintenance <input type="checkbox"/> Repair	Company: Name: Date/ Signature:
<input type="checkbox"/> Inspection Description: <input type="checkbox"/> Maintenance <input type="checkbox"/> Repair	Company: Name: Date/ Signature: